



RAF LIAISON OFFICE
 Royal Air Force Bentwaters Woodbridge Suffolk IP12 2RQ

(110)

Telephone Woodbridge 3737 ext 2333
 XXX 2257

MOD (DS8a)

Your reference

Our reference BENT/019/76
 AIR

Date 15 January 1981

UNIDENTIFIED FLYING OBJECTS (UFO's)

I attach a copy of a report I have received from the Deputy Base Commander at RAF Bentwaters concerning some mysterious sightings in the Rendlesham forest near RAF Woodbridge. The report is forwarded for your information and action as considered necessary.

D H MORELAND
 Squadron Leader
 RAF Commander

Copy to:

SRAFLO, RAF Mildenhall

Copy sent to Ops (SE) 2b Sq WY Bicester

also consulted by Ops (SE) 2b. etc

*DIST
 Ps/ACS (Comms)
 Refer establishments in
 area.*

DEPARTMENT OF THE AIR FORCE
HEADQUARTERS 81ST COMBAT SUPPORT GROUP (USAF)
APO NEW YORK 09755

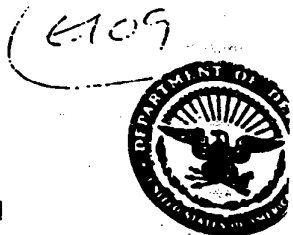

REPLY TO
ATTN OF: CD

SUBJECT: Unexplained Lights

13 Jan 81

TO: RAF/CC

1. Early in the morning of 27 Dec 80 (approximately 0300L), two USAF security police patrolmen saw unusual lights outside the back gate at RAF Woodbridge. Thinking an aircraft might have crashed or been forced down, they called for permission to go outside the gate to investigate. The on-duty flight chief responded and allowed three patrolmen to proceed on foot. The individuals reported seeing a strange glowing object in the forest. The object was described as being metallic in appearance and triangular in shape, approximately two to three meters across the base and approximately two meters high. It illuminated the entire forest with a white light. The object itself had a pulsing red light on top and a bank(s) of blue lights underneath. The object was hovering or on legs. As the patrolmen approached the object, it maneuvered through the trees and disappeared. At this time the animals on a nearby farm went into a frenzy. The object was briefly sighted approximately an hour later near the back gate.
2. The next day, three depressions 1 1/2" deep and 7" in diameter were found where the object had been sighted on the ground. The following night (29 Dec 80) the area was checked for radiation. Beta/gamma readings of 0.1 milliroentgens were recorded with peak readings in the three depressions and near the center of the triangle formed by the depressions. A nearby tree had moderate (.05-.07) readings on the side of the tree toward the depressions.
3. Later in the night a red sun-like light was seen through the trees. It moved about and pulsed. At one point it appeared to throw off glowing particles and then broke into five separate white objects and then disappeared. Immediately thereafter, three star-like objects were noticed in the sky, two objects to the north and one to the south, all of which were about 100' off the horizon. The objects moved rapidly in sharp angular movements and displayed red, green and blue lights. The objects to the north appeared to be elliptical through an 8-12 power lens. They then turned to full circles. The objects to the south was visible for two or three hours and beamed down a stream of light from time to time. Numerous individuals, including the undersigned, witnessed the activities in paragraphs 2 and 3.

CHARLES I. HALT, Lt Col, USAF
Deputy Base Commander

copy taken from 2100011/10/77 - 10/77 - 10/77

29

LOOSE MINUTE

D/DD Ops(GE)10/8

DI 55

Copy to:
PS/ACS(G)(RAF)

UNEXPLAINED LIGHTS

1. During the preparation for the Lords Debate on UFOs on 18 Jan 1979, DI 55 (Mr Asteraki) made contributions to Hd of S4(Air)'s Draft Closing Address and Background note. Since the bulk of reports of unusual sightings have been of a routine nature. However I have been asked by DS8 if any other dept would have an interest in the attached correspondence from the USAF Deputy Base Commander at Bentwaters.
2. We would particularly like to know whether the readings of radioactivity are unusual or whether they are within the normal background range to be expected.

26 Jan 81

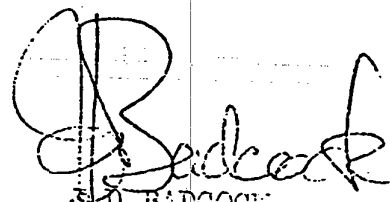
J.D. BADCOCK
Sqn Ldr
Ops(GE)2b(RAF)
MB 4258 7274 MB

Encl: Dept of the Air Force letter 13 Jan 81

012

OOSE MINUTE

D/DD Ops(GE)/10/8

DS8 ←

UNEXPLAINED LIGHTS

Reference: A. D/DS8/72/1/2 dated 20 Jan 81.

1. At Reference you forwarded a report from RAF Bentwaters for information and asked if anyone else might have an interest in the content. You will see from the attached IM, I forwarded a copy to DI55 and PS/ACS(G)(RAF). I have had no response.
2. SOC/CRC Neatishead regret that the radar camera recorder was switched off at 1527Z on 29 Dec 80 and an examination of the executive logs revealed no entry in respect of unusual radar returns or other unusual occurrences.
3. I have spoken with Sqn Ldr Moreland at Bentwaters and he considers the Deputy Base Commander a sound source. I asked if the incident had been reported on the USAF net and I was advised that tape recorders of the evidence had been handed to Gen Gabriel who happened to be visiting the station. Perhaps it would be reasonable to ask if we could have tape recordings as well.

S D BADCOCK
Sqn Ldr
Ops(GE)2b(RAF)
MB 4258 7274 MB

16 Feb 81

4

MEMORANDUM

to DSS.

From CEZL

MOD Form 4A

Date 9/3/81.

Tel 7274

(E35)

Your ref E-36/72/1/2 dated 7/1/81

Our ref D/DOPS(CE)/10/8

Subject UNEXPLAINED NIGHTS

1. Further to my LM at Ref dated 16 Feb attached herewith copies of responses from DISS(a) and DISS — with an offer to pursue from the letter.

J. Budwick
(CE)ZL(RAF)

7274MB

RM

E134

100SE MINUTE

75/103/15/1

Cns (GR) 2b (RAF)

Copy to:
PS/ACS(G)(RAF)

UNEXPLAINED LIGHTS

Reference:

1. D/23 Cps (GE)10/8 dated 26 January 1981.
 1. Having canvassed DSTI for thoughts on this matter, DI55 cannot offer any explanation for the phenomena.
 2. In answer to your specific inquiry regarding the readings of radioactivity, please see the attached correspondence from ADI/DI52.
 3. If you wish to take up ADI/DI52's offer of further assistance, please let me know.

2 March 1981

C F COMPER
DI55(a)
REF 7/26 4131 MB

Enc: DI52/106/10 dated 23 February 1981.

Loose Minute

DI52/108/10

OPR 24/2

DI55a Attn Mr C P Comper

Unexplained Lights

Reference: DI55/108/15/1

1. Like DI55, DI52 do not know of any serious explanation for the phenomena described at reference.
2. Background radioactivity varies considerably due to a number of factors. The value of 0.1 milliroentgens (mr), I assume that this is per hour, seems significantly higher than the average background of about 0.015 mr. I would not expect the variation in this to be much more than a factor of two, although it might be greater for specific reasons.
3. If you wish to pursue this further I could make enquiries as to natural background levels in the area. The way the US report is written, however, suggests that 0.1 mr was greater than they expected.

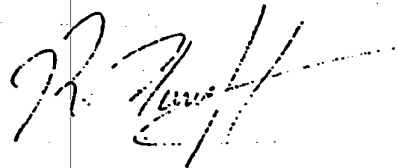

23 February 1981

R C Horscroft
ADI/DI52

Copy taken from File DS8/10/209 Karl E on 1 Sherry 2a

MB

E129/1

LOOSE MINUTE

D/DD Ops(GE)/10/8

DS8 ←

6/209

UFO SIGHTING - RAF WOODBRIDGE DECEMBER 1980

1. At Reference you ask if the suggestion that the USAF be asked for the tape recordings was followed up by this Deputy Directorate. It was considered that the tapes would reveal no better report than that already received, and no further request was made. However, it is considered that your approach to the RAF Liaison officer, will produce any considered views on the event.

2. I believe your outlined response is the right one; Westishhead, which is the Sector Ops Centre responsible for that area had nothing unusual to report, and nothing more substantive has come to light. I have received no evidence that any radar reported unusual tracks. Miss Bandles appears to have "evidence of radar track n", and provided that it can be managed without undermining our position, I would like to have a look at this radar evidence.

21 Mar 83

Baddock

J B BADCOCK
Sqn Ldr
Ops(GE)2b(RAF)
MB 4253 7754 MB

< Note.

Spoke to Giles Cowling at the Defense Radiological Protection Service (0705 584326), re the radiation readings

recorded at the time of the Bantlesham Forest incident.

0.01 would be the general level of background radiation, so

the 0.1 recording is about 10 times what would be normal.

However, military radiation detectors are geared for high level readings, so low-level readings may be difficult to record accurately, as the scale will be small at the bottom of the meter.*

* We don't have details of what instrument was used.

It is just possible to have such an event. A university lab might well have some radioactive source with a very short half life, and could use it so as to give readings, what would not be recorded a few days later.

The level of radiation of 0.1 is completely harmless.

N. Page
15/4/94

* Especially if the needle was fluctuating.

DEPARTMENT OF THE AIR FORCE
HEADQUARTERS 81ST COMBAT SUPPORT GROUP (USAF)
APO NEW YORK 09155



REPLY TO
ATTN OF: CD

13 Jan 81

SUBJECT: Unexplained Lights

TO: RAF/CC

1. Early in the morning of 27 Dec 80 (approximately 0300L), two USAF security police patrolmen saw unusual lights outside the back gate at RAF Woodbridge. Thinking an aircraft might have crashed or been forced down, they called for permission to go outside the gate to investigate. The on-duty flight chief responded and allowed three patrolmen to proceed on foot. The individuals reported seeing a strange glowing object in the forest. The object was described as being metallic in appearance and triangular in shape, approximately two to three meters across the base and approximately two meters high. It illuminated the entire forest with a white light. The object itself had a pulsing red light on top and a bank(s) of blue lights underneath. The object was hovering or on legs. As the patrolmen approached the object, it maneuvered through the trees and disappeared. At this time the animals on a nearby farm went into a frenzy. The object was briefly sighted approximately an hour later near the back gate.
2. The next day, three depressions 1 1/2" deep and 7" in diameter were found where the object had been sighted on the ground. The following night (29 Dec 80) the area was checked for radiation. Beta/gamma readings of 0.1 milliroentgens were recorded with peak readings in the three depressions and near the center of the triangle formed by the depressions. A nearby tree had moderate (.05-.07) readings on the side of the tree toward the depressions.
3. Later in the night a red sun-like light was seen through the trees. It moved about and pulsed. At one point it appeared to throw off glowing particles and then broke into five separate white objects and then disappeared. Immediately thereafter, three star-like objects were noticed in the sky, two objects to the north and one to the south, all of which were about 10° off the horizon. The objects moved rapidly in sharp angular movements and displayed red, green and blue lights. The objects to the north appeared to be elliptical through an 8-12 power lens. They then turned to full circles. The objects to the north remained in the sky for an hour or more. The object to the south was visible for two or three hours and beamed down a stream of light from time to time. Numerous individuals, including the undersigned, witnessed the activities in paragraphs 2 and 3.

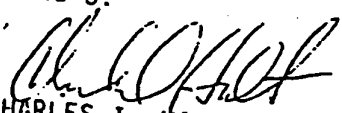
CHARLES I. HALT, Lt Col, USAF
Deputy Base Commander

10

LCOSE MINUTE

E2

D/Sec(AS)12/2/1

25 Jan 94

DPO(RAF) - David Davies

CENTRAL TV UFO DOCUMENTARY - REQUEST FOR INFORMATION ON RENDLESHAM FOREST

1. We spoke yesterday about Central TV's request for information on the UFO sighting in Rendlesham Forest in December 1980.
2. I have been through our file on this incident, and have drawn together an unclassified note based on previous MOD statements. This can be drawn upon in answering questions, or passed to Central TV in toto. I have also attached a copy of Lt Col Halt's report, which can be passed to Central TV.
3. As I mentioned yesterday, Pam Titchmarsh is still in the Department, and works for the Housing Trust Team. I do not know what the rules are with regard to interviews with present or former officials, or whether it would be worthwhile having a word with her. I have not contacted her, but if you wish to do so, she is on 88328MB.
4. Please let me know if you need anything else; as I mentioned, my understanding is that this documentary is to be much more serious than some of the more sensationalist programmes that have been produced in the past. I believe that it will be in our interests to be as helpful as we can, and to try and reflect the good relationship that we now have with many of the more serious UFO groups and researchers. There are still a few within the field who believe that the MOD is involved in a cover-up, and I think the more helpful and open we are, the less likely it is that this view will get an airing.

N. Pope

N G Pope
Sec(AS)2a
MB8245 82140MB

//

UFO SIGHTING AT RENDLESHAM FOREST

We are aware that on 27 and 29 December 1980 a number of personnel from RAF Woodbridge saw strange lights in the vicinity of the base, in Rendlesham Forest.

Lt Col Charles Halt USAF, the Deputy Base Commander, submitted a report on these events, which was passed to the Ministry of Defence. As is the case with all UFO reports submitted to the MOD, Lt Col Halt's report was examined carefully by those staff responsible for the air defence of the United Kingdom. No evidence was found of any threat to the defence of the United Kingdom, and no further investigations were carried out. No further information has come to light which alters our view that the sightings of these lights was of no defence significance.

No unidentified object was seen on radar during the period in question, and there was no evidence of anything having intruded into UK airspace, and landed near RAF Woodbridge.

We are aware that there are a number of theories circulating about these UFO sightings. One theory was that what was seen was the beam of the Orford Ness lighthouse, with distortions being caused by the beam having been seen from through the trees. There were also suggestions that fireball activity might explain some of the lights.

In the absence of any hard evidence, the MOD remains open-minded about these sightings.

DEPARTMENT OF THE AIR FORCE
HEADQUARTERS 81ST COMSAT SUPPORT GROUP (USAF)
APO NEW YORK 09155



REPLY TO
ATTN OF: CD

13 Jan 81

SUBJECT: Unexplained Lights

TO: RAF/CC

1. Early in the morning of 27 Dec 80 (approximately 0300L), two USAF security police patrolmen saw unusual lights outside the back gate at RAF Woodbridge. Thinking an aircraft might have crashed or been forced down, they called for permission to go outside the gate to investigate. The on-duty flight chief responded and allowed three patrolmen to proceed on foot. The individuals reported seeing a strange glowing object in the forest. The object was described as being metallic in appearance and triangular in shape, approximately two to three meters across the base and approximately two meters high. It illuminated the entire forest with a white light. The object itself had a pulsing red light on top and a bank(s) of blue lights underneath. The object was hovering or on legs. As the patrolmen approached the object, it maneuvered through the trees and disappeared. At this time the animals on a nearby farm went into a frenzy. The object was briefly sighted approximately an hour later near the back gate.

2. The next day, three depressions 1 1/2" deep and 7" in diameter were found where the object had been sighted on the ground. The following night (29 Dec 80) the area was checked for radiation. Beta/gamma readings of 0.1 milliroentgens were recorded with peak readings in the three depressions and near the center of the triangle formed by the depressions. A nearby tree had moderate (.05-.07) readings on the side of the tree toward the depressions.

3. Later in the night a red sun-like light was seen through the trees. It moved about and pulsed. At one point it appeared to throw off glowing particles and then broke into five separate white objects and then disappeared. Immediately thereafter, three star-like objects were noticed in the sky, two objects to the north and one to the south, all of which were about 10° off the horizon. The objects moved rapidly in sharp angular movements and displayed red, green and blue lights. The objects to the north appeared to be elliptical through an 8-12 power lens. They then turned to full circles. The objects to the north remained in the sky for an hour or more. The object to the south was visible for two or three hours and beamed down a stream of light from time to time. Numerous individuals, including the undersigned, witnessed the activities in paragraphs 2 and 3.

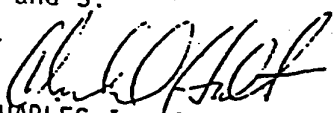
CHARLES I. HALT, Lt Col, USAF
Deputy Base Commander



RAF LIAISON OFFICE
Royal Air Force Bentwaters Woodbridge Suffolk IP12 2RQ
Telephone Bentwaters (0394) 432557

E26

Mr N G Pope
Secretariat (Air Staff)2a
Room 8245
Ministry of Defence
Main Building
Whitehall
LONDON SW1A 2HB

BENT/1/2/AIR

8 July 1992

Dear Mr Pope

UFO SIGHTING - DECEMBER 1980

Reference:

A. D/Sec(AS)12/2/1 dated 2 July 1992.

1. I refer to your letter at Reference A concerning the reported sighting of a UFO on 27 December 1980. I have no records on this subject and the file to which you refer has long since been destroyed.

2. However, I have spoken with our resident Historian from the 81st Tactical Fighter Wing who has unearthed an article which I have photocopied for your information. It all makes interesting reading.

Yours sincerely

P. ROONEY
Squadron Leader
RAF Commander

WOODBIDGE RAF/USAF AIR BASE

In December 1980 it is alleged that a grounded UFO was seen in the Rendlesham Forest area outside the back gates of RAF/USAF Woodbridge in Suffolk, England.

There are various, and conflicting, reports about what occurred on the night. According to the official report made by the Deputy Base Commander, Lieutenant-Colonel Charles Halt, two security police witnessed lights outside the back gate and called for permission to investigate on the grounds that an aircraft might have crashed. Three patrolmen were sent and they reported seeing a glowing object in the forest, described as triangular in shape, about 9 feet wide and 6 feet high, and emanating a powerful white light. Other reports detail blue and red lights at various points on the object. It was either hovering or standing on short legs and as the patrol approached, it manoeuvred away slowly through the trees on to a nearby farm (causing some disturbance in the animals there) before disappearing into the sky very quickly. However, the object was briefly sighted again about an hour later.

Investigation the following day found three ground traces indicating possible landing leg depressions.

However, there are other stories of events that night including one that the overall Commander of the base, Wing Commander Gordon Williams, was present at the investigation and also communicated with aliens that had been seen apparently carrying out repairs to the craft.

It is alleged that many films and photographs were taken but that these were all confiscated by senior officers and have not been released.

Investigators examining these claims have obtained interviews with two of the patrol who investigated the UFO, airman John Burroughs and a second airman who remains anonymous and is given the pseudonym of James Archer. Basically their stories agree with the Deputy Commander's statement. Archer denies seeing aliens but saw shapes inside the object, to which he had approached within three feet, and commented, 'I don't know what they were but the shapes did not look human. Maybe they were like robots.'

One of the security police at Woodbridge, Sergeant Adrian Bustinza, came forward after the publication of a book, *Skycrash* by Jenny Randles, Brenda Butler and Dot Street (see References and Background Material), and told his detailed version of events in the forest that night. Again, for the most part, his account basically agrees with that of Lieutenant-Colonel Halt. He describes the object as being seen through a yellow mist like 'nothing I have ever seen before', and comments that it was a tremendous size compared to the clearing it was in and that he was surprised it was able to fit into the area. One major discrepancy arises in his description, however; he describes it as saucer-shaped rather than triangular-shaped, which would seem to be a very major disagreement considering both reports come from eye witnesses.

There is allegedly a tape recording made by Lieutenant-Colonel Halt and his men while in the forest investigating the event and part of this has

been released by a former base commander at Woodbridge, Colonel Morgan. On the tape various voices including Lieutenant-Colonel Halt describe what they are supposed to be seeing as they pursue the object through the woods.

When challenged by a former Chief of the Defence Staff, Admiral the-Fleet Lord Hill-Norton, the Secretary of State for Defence, Michael Heseltine, through Lord Trefgarne, released the statement that the events to which you refer were of no defence significance.

As Lord Hill-Norton put it, there would seem to be some defence significance either in an unknown object's entering and possibly landing in British territory or, alternatively, a deputy base commander of an RAF/USAF base filing a ludicrous and make-believe report. Lieutenant-Colonel (now Colonel) Halt has confirmed subsequently that this memorandum is legitimate. He also went on to say, 'There are a lot of things that are not in my memo.'

WOODRUFF, R. S.

In many people's eyes the quality of the witness to a UFO event is as important as the event itself. On that basis one sighting of three red lighted UFOs buzzing low over cars near Bethel in Vermont, USA should rank highly. Witnesses in other cars watched a police car ahead being buzzed. The police car contained a high State police official and the State pathologist, Dr R. S. Woodruff.

Calculation by the police indicated that the speed of the UFOs was some 2,000 miles per hour.

Despite the fact that the UFOs had come down precisely together in line of formation, slowed down and flown parallel to the ground, the Air Force explained that they were only meteors.

WRIGHT PATTERSON AIR FORCE BASE

Wright Patterson Air Force Base in America is a name that frequently occurs in the pages of this encyclopedia and in the annals of UFO research.

It is alleged that this base is the storehouse and examination facility for retrieved crash flying saucers and also for alien bodies.

Other stories have it that Wright Patterson contains a 'quick reaction force' designed to retrieve downed saucers, a sort of SAS or SWAT team to deal with aliens.

There is even an allegation that Senator Barry Goldwater attempted to gain entry to the base to examine UFO evidence but was refused by the then commanding officer, General Curtis LeMay.

WYKOFF, LIEUTENANT ROBERT C.

On 10 August 1950 Navy physicist Lieutenant Robert Wykoff, using Navy binoculars, watched a large disc-shaped UFO manoeuvring near Edwards Air Force Base, the scene of many such sightings.



From: N G Pope, Secretariat(Air Staff)2a, Room 8245

MINISTRY OF DEFENCE
Main Building Whitehall London SW1A 2HB

Telephone (Direct Dialling) 071-21-8 2140
(Switchboard) 071-21-89000
(Fax) 071-21-8

E2

Sqn Ldr P Rooney
RAF Commander
RAF Bentwaters
Woodbridge
Suffolk
IP12 2RQ

Your reference

Our reference

D/Sec(AS)12/2/1

Date

2 July 1992

Dear Sqn Ldr Rooney,

1. I am writing concerning the background to the UFO sighting near RAF Woodbridge on 27 December 1980, and the report that was subsequently made by the USAF Deputy Base Commander, Lt Col Halt.
2. I have attached a copy of a letter from one of your predecessors, together with a copy of Lt Col Halt's report, and I have two requests:
 - a. If you have files going back this far, could I have a copy of the original covering letter, BENT/19/76/Air dated 15 January 1981. I believe our copy was archived some time ago.
 - b. I would be grateful if you would confirm that Lt Col Halt's report is a genuine USAF report; this may sound a strange request, but over the years there have been a very clever series of hoax documents produced on the subject of UFOs. These often relate to official government/military knowledge of UFOs, and often appear to be on official notepaper - presumably using genuine official letters sent to members of the public, with the hoax text placed over the genuine text, and then photocopied again. In the absence of all the background papers, I am unsure as to the exact circumstances under which this report first surfaced. I do not know what standard practice would be, but would such a report not have been submitted on paper with a Bentwaters/Woodbridge address?
3. This may all seem like ancient history, but this alleged incident has become the best known UFO story in the UK, being mentioned in dozens of books on the subject (including one entire book relating the story of how USAF personnel repaired a crashed flying saucer and communicated with its alien occupants!). We still receive a steady stream of telephone enquiries and letters on the subject even to this day.

Yours sincerely,

N. Pope

17

3

paper



RAF LIAISON OFFICE
 Royal Air Force Bentwaters Woodbridge Suffolk IP12 2RQ
 Telephone Woodbridge 3737 ext 2257

Reply sent.
E132

MOD(DS8a)

Your reference

Our reference
 BENT/19/76/Air

Date
 25 October 1982

UNIDENTIFIED FLYING OBJECTS (UFO's)

Reference:

A. BENT/19/76/Air dated 15 January 1981.

1. Under cover of reference A I forwarded you a copy of the Deputy Base Commander's report concerning some unexplained lights and sightings on 27/29 December 1980. Some time after the incident I was approached by two women who claimed to be UFO investigators, but I refused to confirm or deny their claims. A week ago I was telephoned from New York by a Mr Eric Mishara from Omie Magazine. He asked me questions about an article in a British UFO Magazine. He claimed he was a serious UFO investigator and wanted to write an objective article about the incident. I told him that whoever wrote the article he described to me must have had a vivid imagination.

2. I have now managed to obtain a copy of the article and enclose a copy for your information. The magazine is called "The Unexplained" published weekly by:

ORBIS Publishing Ltd
 Orbis House
 20/22 Bedfordbury
 London WC2N 4BT

The article was in Volume 9 Issue No 106.

3. I now anticipate a flood of enquiries and would be grateful for some guidance on MOD Policy concerning UFO's.

D E MORELAND
 Sen Ldr
 RAF Cdr

DEPARTMENT OF THE AIR FORCE
HEADQUARTERS 81ST COMBAT SUPPORT GROUP (USAF)
APO NEW YORK 09755



REPLY TO
ATTN OF: CD

13 Jan 81

SUBJECT: Unexplained Lights

TO: RAF/CC

1. Early in the morning of 27 Dec 80 (approximately 0300L), two USAF security police patrolmen saw unusual lights outside the back gate at RAF Woodbridge. Thinking an aircraft might have crashed or been forced down, they called for permission to go outside the gate to investigate. The on-duty flight chief responded and allowed three patrolmen to proceed on foot. The individuals reported seeing a strange glowing object in the forest. The object was described as being metallic in appearance and triangular in shape, approximately two to three meters across the base and approximately two meters high. It illuminated the entire forest with a white light. The object itself had a pulsing red light on top and a bank(s) of blue lights underneath. The object was hovering or on legs. As the patrolmen approached the object, it maneuvered through the trees and disappeared. At this time the animals on a nearby farm went into a frenzy. The object was briefly sighted approximately an hour later near the back gate.
2. The next day, three depressions 1 1/2" deep and 7" in diameter were found where the object had been sighted on the ground. The following night (29 Dec 80) the area was checked for radiation. Beta/gamma readings of 0.1 milliroentgens were recorded with peak readings in the three depressions and near the center of the triangle formed by the depressions. A nearby tree had moderate (.05-.07) readings on the side of the tree toward the depressions.
3. Later in the night a red sun-like light was seen through the trees. It moved about and pulsed. At one point it appeared to throw off glowing particles and then broke into five separate white objects and then disappeared. Immediately thereafter, three star-like objects were noticed in the sky, two objects to the north and one to the south, all of which were about 10° off the horizon. The objects moved rapidly in sharp angular movements and displayed red, green and blue lights. The objects to the north appeared to be elliptical through an 8-12 power lens. They then turned to full circles. The objects to the south remained in the sky for an hour or more. The object to the south was visible for two or three hours and beamed down a stream of light from time to time. Numerous individuals, including the undersigned, witnessed the activities in paragraphs 2 and 3.

CHARLES I. HALT, Lt Col, USAF
Deputy Base Commander

(E24)

file copy

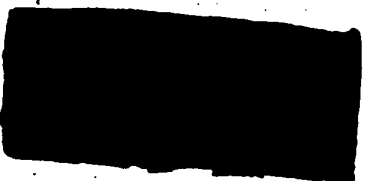

D/Sec(AS)12/2/1

5 August 1987



Thank you for your letter dated 31 June which requested information on the Rendlesham Forest "incident". As we mentioned to you in our letter dated 16 May 1986 the only information that we have on this alleged UFO sighting is the report by the Deputy Base Commander of RAF Woodbridge, Lieutenant Colonel Charles Halt, USAF. In case you haven't seen it before I attach a copy of the report which may be of interest to you. You may recall that the sole interest of the Ministry of Defence in reported sightings of UFOs is to establish whether they have any bearing on the defence of the country. We are satisfied that the events described in Lieutenant Colonel Halt's report are of no defence significance.

I hope that this proves useful.

YK
[Signature]

To aff.

OK file
Thaw. (E33)

Draft response to [redacted] letter
of 31/6/87 is attached.

Lt. Col Halt's report of Jan '81 (see file)
has already been released by sec(As)
to a number of members of the public.

G
48.

Gilbert 17/7

[redacted] has written about Rendlesham Forest on several occasions. Our first reply gave him a standard letter explaining our interest in UFO's [E67 Part A]. His second letter [E5 Part 6] did not receive a reply. His third asked us to determine whether or not the Rendlesham Forest incident involved a UKAF "stealth" plane. He answered a simple "NO". (E's 31+32 Pt B)

My reply to [redacted] again explains our policy on UFO's and as he appears not to have a copy, I have included a copy of Lt Col Hall's report. This has been released to other ufologists in the past.

Clive

Thank you. Would you please locate Lt Col Hall's report, & also the example of its release to other ufologists in the past.
Gish

CA 15/07

Examples: E17 pt A 12/2/
E16 pt A 12/2/1
(flagged)
these are plenty more.
CA 15/7



replied 05/02
to

(E21)

Dear Mr Ross.

I have enclosed a photo, for which I think will amuse you.
I would be very grateful if you could send me any information
that you may have on the Rendelsham forest case in "Dec 1980".
If you don't have any information in the ministry could you
tell me where to obtain some information on this case.

YOURS SINCERELY.

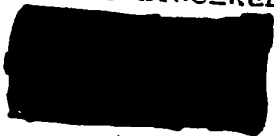

12/ 2/1

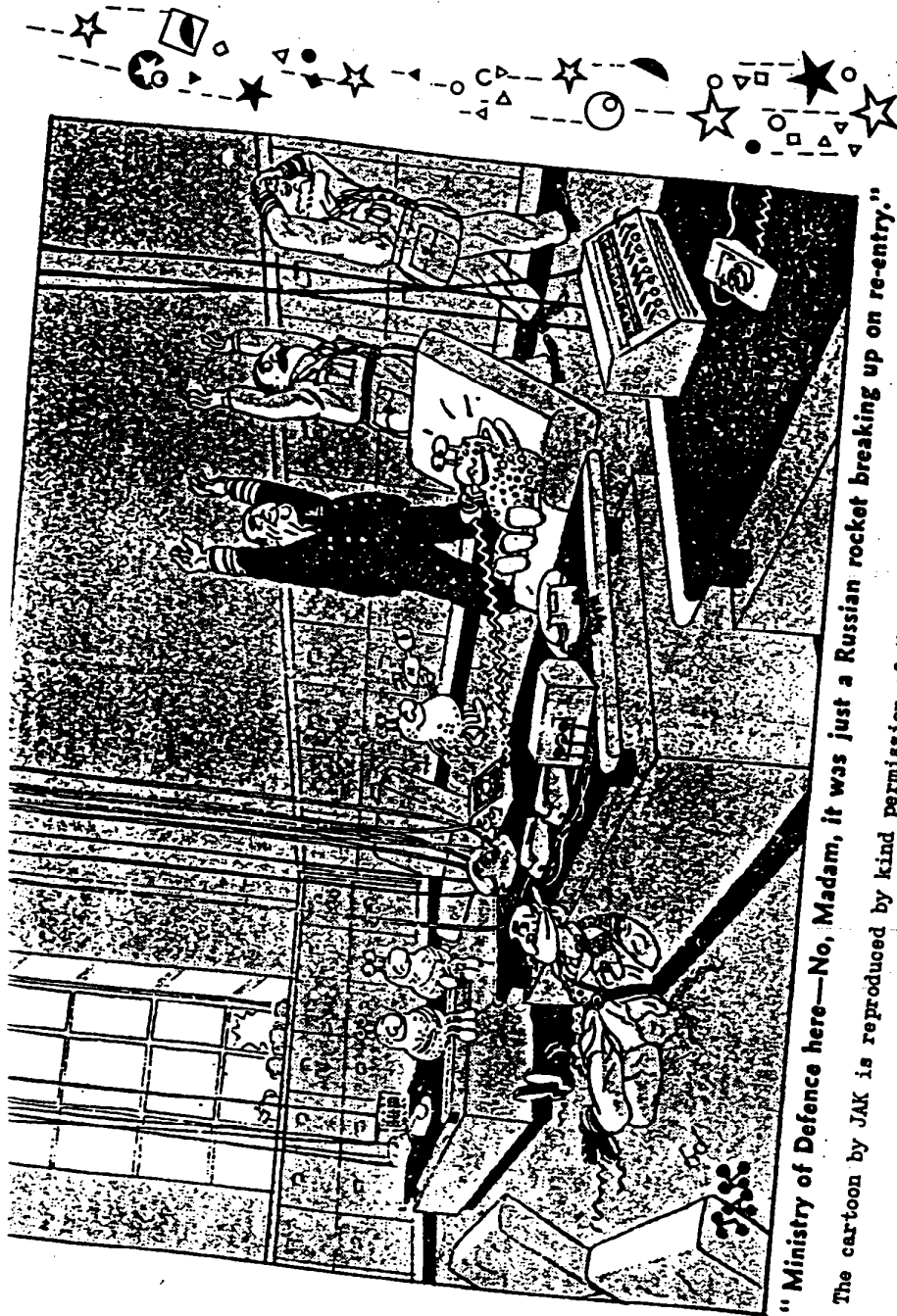

"Ministry of Defence here—No, Madam, it was just a Russian rocket breaking up on re-entry."
The cartoon by JAK is reproduced by kind permission of the London "EVENING STANDARD" (22/NOV/68)

From: P M Hucker, Secretariat (Air Staff)2a, Room 8245

E20



MINISTRY OF DEFENCE
Main Building Whitehall London SW1A 2HB

Telephone 01-218 (Direct Dialling)
01-218 9000 (Switchboard)



Your reference

Our reference D/Sec(AS)12/2/1 ✓

Date 21 August 1985



Thank you for your letter of 9 July 1985. The Ministry of Defence's interest in Unidentified Flying Objects (UFO's) was explained to you by my predecessor, Mr Mathewson, in his letters of 19 June and 18 July 1984.

The only information we have on the alleged "UFO sighting" at Rendlesham Forest in December 1980 is the report by Colonel Charles Halt, of the United States Air Force. We are satisfied that the events described are of no defence significance. We can find nothing in our records to suggest that alleged eye-witnesses were interviewed by the MOD, this is consistent with our normal practice when dealing with UFO reports.

Yours sincerely
P M Hucker

OUR REF:

YOUR REF:

D/DS8/10/209

Ministry of Defence,
Main Building, Rm 7230,
Whitehall,
London.
SW1A 2HB

For the attention of A. Mathewson Esq.

Dear Mr. Mathewson,

re: UFO Sighting at Rendlesham Forest

I would be grateful if you could kindly indicate to me if your Department interviewed any of the alleged eye witnesses to the above incident and if so, whom and the dates of such interviews.

Kind regards.

Yours sincerely,

[Redacted signature]

PP: 10/209/44
12/2/1

(E 14) (S & P)

9th July 1985



MINISTRY OF DEFENCE
Main Building Whitehall London SW1A 2HB

Telephone 01-218 (Direct Dialling)
01-218 9000 (Switchboard)

Sec(AS)2a, Room 8245

(E18)

[REDACTED]

Your reference

Our reference

D/Sec(AS)12/2/1 ✓

Date

2 July 1985

[REDACTED]

Your letter of 3 March 1985, addressed to the Office of Public Information, has been passed to me for reply. I am sorry that you received no reply to your earlier letter, however I can find no trace of it in our records. You may find it useful if I explain that the sole interest of the United Kingdom Ministry of Defence in reported sightings of Unidentified Flying Objects (UFOs) is to establish whether they have any bearing on the defence of the country.

There is no organisation in the Ministry of Defence appointed solely for the purpose of studying reports of such objects, and no staff are employed on the subject full time. The reports we receive are referred to the staff in the Department who are responsible for the air defence of the United Kingdom, and they examine the reports as part of their normal duties.

Since our interest in UFOs is limited to possible defence implications we have not carried out a study into the scientific significance of these phenomena. Unless there are defence implications we do not attempt to identify sightings and we cannot inform observers of the probable identity of the object seen. The Department could not justify the expenditure of public funds on investigations which go beyond the pure defence interests.

We have to recognise that there are many strange things to be seen in the sky, but we believe there are adequate explanations for them. They may be satellite debris re-entering the earth atmosphere, ball lightning, unusual cloud formations, meteorological balloons, aircraft lights, aircraft at unusual angles or many other things.

The only information we have on the alleged "UFO sighting" at Rendlesham Forest in December 1980 is the report by Colonel Charles Halt, of the United States Air Force. We are satisfied that the events described are of no defence significance.

[REDACTED]

24
12/2/1

March 3, 1985

Office of Public Information
Ministry of Defence
Air Ministry section
London, England

Gentlemen:

In a letter dated November 18, 1984 I requested certain information from your office in regard to a number of UFO incidents that occurred in the immediate vicinity of the Bentwaters/Woodbridge NATO airbase complex in the county of Suffolk, during the last week of December 1980. It is most disappointing that to this date I have received NO reply.

It is my sincere hope that you will respond to the following questions;

- 1) Does your office confirm receipt of the letter from USAF Lt. Col. Charles I. Halt, Deputy Base Commander, describing the UFO incidents?
- 2) Did your office conduct, or participate in, any further inquiry into this matter? Also, does your office maintain a dossier on this matter?
- 3) Can you suggest any prosaic explanation for these specific incidents?



MINISTRY OF DEFENCE
 Main Building Whitehall London SW1A 2HB
 Telephone 01-218 (Direct Dialling)
 01-218 8000 (Switchboard)

Sec(AS)2a, Room 8245

C1

[REDACTED]

Your reference
 Our reference D/Sec(AS)12/2/1 ✓
 Date 2 July 1985

[REDACTED]

Thank you for your letter of 15 April. You may find it useful if I explain that the sole interest of the United Kingdom Ministry of Defence in reported sightings of Unidentified Flying Objects (UFOs) is to establish whether they have any bearing on the defence of the country.

There is no organisation in the Ministry of Defence appointed solely for the purpose of studying reports of such objects, and no staff are employed on the subject full time. The reports we receive are referred to the staff in the Department who are responsible for the air defence of the United Kingdom, and they examine the reports as part of their normal duties.

Since our interest in UFOs is limited to possible defence implications we have not carried out a study into the scientific significance of these phenomena. Unless there are defence implications we do not attempt to identify sightings and we cannot inform observers of the probable identity of the object seen. The Department could not justify the expenditure of public funds on investigations which go beyond the pure defence interests.

We have to recognise that there are many strange things to be seen in the sky, but we believe there are adequate explanations for them. They may be satellite debris re-entering the earth atmosphere, ball lightning, unusual cloud formations, meteorological balloons, aircraft lights, aircraft at unusual angles or many other things.

The only information we have on the alleged "UFO sighting" at Rendlesham Forest in December 1980 is the report by Colonel Charles Halt, of the United States Air Force. We are satisfied that the events described are of no defence significance. I enclose a copy of Colonel Halt's report which may be of interest.

Yours sincerely

P M HUCKER

DEPARTMENT OF THE AIR FORCE
HEADQUARTERS 81ST COMBAT SUPPORT GROUP (USAF)
APO NEW YORK 07155

6109
UNITED STATES AIR FORCE

REPLY TO
ATTN OF: CID

SUBJECT: Unexplained Lights

13 Jan 81

RAF/CC

Early in the morning of 27 Dec 80 (approximately 0300L), two USAF security police patrolmen saw unusual lights outside the back gate at RAF Woodbridge. Thinking an aircraft might have crashed or been forced down, they called for permission to go outside the gate to investigate. The on-duty flight chief responded and allowed three patrolmen to proceed on foot. The individuals reported seeing a strange glowing object in the forest. The object was described as being metallic in appearance and triangular in shape, approximately two to three meters across the base and approximately two meters high. It illuminated the entire forest with a white light. The object itself had a pulsing red light on top and a bank(s) of blue lights underneath. The object was hovering or on legs. As the patrolmen approached the object, it maneuvered through the trees and disappeared. At this time the animals on a nearby farm went into a frenzy. The object was briefly sighted approximately an hour later near the back gate.

2. The next day, three depressions 1 1/2" deep and 7" in diameter were found where the object had been sighted on the ground. The following night (29 Dec 80) the area was checked for radiation. Beta/gamma readings of 0.1 milliroentgens were recorded with peak readings in the three depressions and near the center of the triangle formed by the depressions. A nearby tree had moderate (.05-.07) readings on the side of the tree toward the depressions.

3. Later in the night a red sun-like light was seen through the trees. It moved about and pulsed. At one point it appeared to throw off glowing particles and then broke into five separate white objects and then disappeared. Immediately thereafter, three star-like objects were noticed in the sky, two objects to the north and one to the south, all of which were about 100 off the horizon. The objects moved rapidly in sharp angular movements and displayed red, green and blue lights. The objects to the north appeared to be elliptical through an 8-12 power lens. They then turned to full circles. The objects to the south remained in the sky for an hour or more. The object to the south was visible for two or three hours and beamed down a stream of light from time to time. Numerous individuals, including the undersigned, witnessed the activities in paragraphs 2 and 3.

CHARLES I. HALT, Lt Col, USAF
Deputy Base Commander



April 15th. '35.

Dear Sir,

In the late 1970's my daughter saw what could only be described as an unidentified flying object over Accrington in Lancashire.

Since then I have met several people who have had a similar experience, and I have recently read a library book 'SKYCRASH'.

Over the past few years my interest in this phenomina has increased, therefore I wonder if you could let me have any further information or copies of documents relating to the incident in Rendlesham Forest in December 1930?

Your co-operation would be much appreciated.

Sincerely yours,

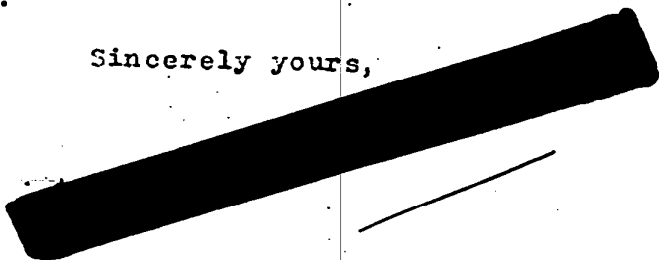

31

I attach copies of two recent Parliamentary Questions on the Ministry of Defence's interest in UFO reports, which you may be interested in.

Yours sincerely



P M HUCKER

DEPARTMENT OF THE AIR FORCE
HEADQUARTERS 81ST COMBAT SUPPORT GROUP (USAF)
APO NEW YORK 09555

E109



13 Jan 81

REPLY TO
ATTN OF: (C)

SUBJECT: Unexplained Lights

10: RAF/CC

1. Early in the morning of 27 Dec 80 (approximately 0300L), two USAF security police patrolmen saw unusual lights outside the back gate at RAF Woodbridge. Thinking an aircraft might have crashed or been forced down, they called for permission to go outside the gate to investigate. The on-duty flight chief responded and allowed three patrolmen to proceed on foot. The individuals reported seeing a strange glowing object in the forest. The object was described as being metallic in appearance and triangular in shape, approximately two to three meters across the base and approximately two meters high. It illuminated the entire forest with a white light. The object itself had a pulsing red light on top and a bank(s) of blue lights underneath. The object was hovering or on legs. As the patrolmen approached the object, it maneuvered through the trees and disappeared. At this time the animals on a nearby farm went into a frenzy. The object was briefly sighted approximately an hour later near the back gate.

2. The next day, three depressions 1 1/2" deep and 7" in diameter were found where the object had been sighted on the ground. The following night (29 Dec 80) the area was checked for radiation. Beta/gamma readings of 0.1 milliroentgens were recorded with peak readings in the three depressions and near the center of the triangle formed by the depressions. A nearby tree had moderate (.05-.07) readings on the side of the tree toward the depressions.

3. Later in the night a red sun-like light was seen through the trees. It moved about and pulsed. At one point it appeared to throw off glowing particles and then broke into five separate white objects and then disappeared. Immediately thereafter, three star-like objects were noticed in the sky, two objects to the north and one to the south, all of which were about 10° off the horizon. The objects moved rapidly in sharp angular movements and displayed red, green and blue lights. The objects to the north appeared to be elliptical through an 8-12 power lens. They then turned to full circles. The object to the south remained in the sky for an hour or more. The object to the south was visible for two or three hours and beamed down a stream of light from time to time. Numerous individuals, including the undersigned, witnessed the activities in paragraphs 2 and 3.

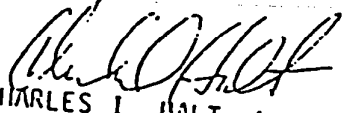
CHARLES I. HALT, Lt Col, USAF
Deputy Base Commander

33

Hansard Extract

13 March 1984

Cols 132 & 133

Unidentified Flying Objects

Sir Patrick Wall asked the Secretary of State for Defence (1) how many alleged landings by unidentified flying objects have been made in 1980, 1981, 1982 and 1983, respectively; and how many have been investigated by his Department's personnel;

(2) how many unexplained sightings there have been in 1980, 1981, 1982 and 1983, respectively; and which of these had been traced by radar and with what result.

Mr. Lee (*pursuant to his reply; 9 March 1984, c. 728*):
For the years in question, the Ministry of Defence received the following numbers of reports of sightings of flying objects which the observer could not identify: 350, 600, 250, and 390. Reports of alleged landings are not separately identified. The Department was satisfied that none of these reports was of any defence significance and, in such cases, does not maintain records of the extent of its investigations.

HAZARD EXTRACT

24 OCTOBER 1983

Col. 62

RAF Woodbridge (Alleged Incident)

Sir Patrick Wall asked the Secretary of State for Defence (1) if he has seen the United States Air Force memo dated 13 January 1981 concerning unexplained lights near RAF Woodbridge;

(2) whether, in view of the fact that the United State's Air Force memo of 13 January 1981 on the incident at RAF Woodbridge has been released under the Freedom of Information Act, he will now release reports and documents concerning similar unexplained incidents in the United Kingdom;

(3) how many unexplained sightings or radar intercepts have taken place since 1980.

Mr. Stanley: I have seen the memorandum of 13 January 1981 to which my hon. Friend refers. Since 1980 the Department has received 1,400 reports of sightings of flying objects which the observers have been unable to identify. There were no corresponding unexplained radar contacts. Subject to normal security constraints, I am ready to give information about any such reported sightings that are found to be a matter of concern from a defence standpoint, but there have been none to date.



MINISTRY OF DEFENCE Sec(AS)2
Main Building Whitehall London SW1A 2HB
Telephone 01-218 (Direct Dialling)
01-218 9000 (Switchboard)

E16

[REDACTED]

Your reference

Our reference

Date D/Sec (AS) 12/2/11 ✓
28 June 1985

[REDACTED]

Thank you for your letter of 25 March 1985. You may find it useful if I explain that the sole interest of the United Kingdom Ministry of Defence in reported sightings of Unidentified Flying Objects (UFOs) is to establish whether they have any bearing on the defence of the country.

There is no organisation in the Ministry of Defence appointed solely for the purpose of studying reports of such objects, and no staff are employed on the subject full time. The reports we receive are referred to the staff in the Department who are responsible for the air defence of the United Kingdom, and they examine the reports as part of their normal duties.

Since our interest in UFOs is limited to possible defence implications we have not carried out a study into the scientific significance of these phenomena. Unless there are defence implications we do not attempt to identify sightings and we cannot inform observers of the probable identity of the object seen. The Department could not justify the expenditure of public funds on investigations which go beyond the pure defence interests.

We have to recognise that there are many strange things to be seen in the sky, but we believe there are adequate explanations for them. They may be satellite debris re-entering the earth atmosphere, ball lightning, unusual cloud formations, meteorological balloons, aircraft lights, aircraft at unusual angles or many other things.

The only information we have on the alleged "UFO sighting" at Rendlesham Forest in December 1980 is the report by Colonel Charles Halt, of the United States Air Force. We are satisfied that the events described are of no defence significance. I can assure you that there is no question of attempting to cover up any incident or mishap, nor are we attempting in any way to obscure the truth. I enclose a copy of Colonel Halt's report which may be of interest.

36

NOTE

Please inform if your dept does have a procedure that can be arranged that would assure that any large volume of documents could be sent via Air Mail if yes the cost of mailing first class Air Mail I would like to arrange to receive all documents that your dept can release to me this method if you can estimate the cost of this procedure then please reply have provided a return reply envelope with Air Mail stamps on it for courtesy reply will mail the amount to pay for mailing via Air Mail of package first class if volume of documents is large or small either amount I will be happy to forward the amount as instructed by the dept you work in thank you very much

from

file
12/2/1

MINISTRY OF DEFENSE
MAIN BUILDING WHITEHALL
LONDON ENGLAND SW1A-2HB
DEFENSE SECRETARIAT 8
ANDREW MATHEWSON

March 25th 1985

Dear Sirs

I am presently involved in doing some background research into a book titled Sky Crash A Cosmic Conspiracy by Dot Street Brenda Butler and Jenny Randles. I would like to verify some basic facts discussed in this book as they were writing about the MOD DS8 and its capacity or involvement into the Rendlesham Forrest (UFO Unknown Lights) of December 27th and the 30th 1980. The copy of the report that they obtained from the MOD DS8 as it concerns your dept and I am asking of that particular report if a copy of this report is available to the general public if requested. I am aware that the report was sent by Squadron Leader Donald Moreland on January 14th 1981 to the MOD DS8 a copy of this report will be enclosed with this letter plus additional version of that report that should probably be regarded as not very accurate on details or facts surrounding this case in particular also I understand that RAF Watten had picked up on their radar and tracked this UFO to about fifty miles south and to the east of Ipswich and in the general vicinity of the Rendlesham Forrest after which they lost radar contact. This occurred on the night of December 27th 1980 and the radar recordings were examined by USAF intelligence officers concerning this uncorrelated target such recordings are kept a few days before being reused this is a precaution against the unforeseen such as a air crash of an airplane. I believe a rumor circulating around the radar base was that it was possible that a object that they had tracked had crash landed into the forest near Ipswich. This had been a metallic UFO, a structured device of unknown origin. Men who had gone out to confront the UFO from a nearby base had found the engine and lights of their jeep failing as they got closer. They then had to continue on foot. The object was on the ground for several hours before repairs could be undertaken by the aliens who crewed it. During this period high ranking officers from the base went into the forest and the base commander himself we assume Colonel Gordon Williams had conversed with the occupants. It is no known what the radar men made of this tale, but it was apparently told by a radar man to the authors. But the fact that they tracked a target which aroused considerable interest in the USAF was certainly intriguing.

about your dept, there is a basic one page file for each UFO report that you would receive. now about regulations that direct persons to send UFO reports to your dept, and can I obtain a copy of these documents that exist that dictate guidelines a sort of official document that informs police and military about why these reports are important to the MOD DS8 and why this particular dept has been chosen for this assignment of evaluating of the UFO sighting reports that are sent through official channels and is there any joint cooperation between your government and other NATO allies with regards to this UFO phenomena and channeling of important data on specific UFO sighting cases that warrant other NATO Allies being informed about progress in investigating a particular case like the Rendlesam Forrest incidents that were highly documented and by official channels and by higher ranking personnel were involved which is indeed very unusual does your office ever conduct any field investigations on UFO sighting reports looking into background of a particular sighting that has physical traces with photographic evidence of a UFO and photos of the landing sight showing actual physical traces left behind by the UFO and does your dept have a manual for reference of different categories of these UFOs like the MUFON field investigators manual which is a guide explaining some of the differences between IFOs Identified Flying Objects Unidentified Flying Objects and basis rules to help determine category of the UFO sighting what is your department step by step procedures for investigating these UFO sighting reports where not secret I am very interested in obtaining some more detailed information on how a military base might be instructed in investigating a UFO sighting within their own military base property or do they just send in a brief sighting report how much details would be important to sufficiently investigate the UFO sighting to determine the defense implications of that particular report and has the MI5 or MI9 intelligence services ever been utilized to obtain more additional UFO reports this I understand and is a possibility for additional UFO reports do you know of the British government and whether its intelligence apparatus is doing any monitoring of the UFO phenomena for possible intelligence information of some benefit to British military security am aware that our National Security Agency and the Central Intelligence Agency are doing some secret monitoring of the UFO phenomena for national security reasons which are considered valid enough

I wish to thank you for your kind and gracious assistance

SINCERLY

Signed [REDACTED]

39

from

DEPARTMENT OF THE AIR FORCE
AIR FORCE OFFICE OF SPECIAL INVESTIGATIONS
CHIEF OF INFORMATION RELEASE
NOAH D LAWRENCE WASHINGTON D.C. 20330-5025

MARCH 8th 1985

I am presently involved in some background research investigating on a book titled Clear Intent by Barry Greenwood and Larry Fawcett on page 224 of their book a report is discussed which originated from Kirckland AFB N.M. dated 2-9 Sept 80 OSI complaint form for official use only 8 Aug 3 80 alleged sightings of Unidentified Aerial Lights in restricted test range the file # is 8017D93-0/29 I wish to ask if you can release the complete file under the Freedom of Information Act 5 USC552 and can I please receive a copy of this file the following incidents are on file at the British Ministry Of Defense their address is Main Building Whitehall London SW1A-2HB the present head of the UFO report receiving dept DS8 is Andrew Mathewson however not knowing how their government would respond to an inquiry from a citizen of a foreign country about documents that the British Government might regard as sensitive enough as far as being of a high security nature a reply possibly would not be given here concerning a official report probably regarded as confidential meaning not for distribution to persons with out a security clearance I should point out that the report is on page 218 of the book Clear Intent and on (page 22 and 23 of the book Sky Crash A Cosmic Conspiracy by Brenda Butler Dot Street and Jenny Randles) the report has been photoduplicated in its entirety in both books what I am interested in verifying here is the existence of the report and possibly additional documents in the form of an open file this is the filed report written as follows DEPARTMENT OF THE AIR FORCE HEADQUARTERS 81st Combat Support Group RAF Bentwaters filed by Deputy Base Commander Lt, Col, USAF CHARLES I HALT dated January 13th 1981 subject Unexplained Lights 1. Early in the mourning of 27 Dec 80 (approximately 0300) two USAF security police patrolman saw unusual lights outside the back gate at RAF Woodbridge. Thinking an aircraft might have crashed or been forced down, they called for permission to go outside the gate to investigate. The on duty flight chief responded and allowed three patrolmen to proceed on foot. The individuals reported seeing a strange bright object in the forrest. The object was described as being metallic in appearance and triangular in shape approximately two to three meters across the base and approximately two meters high. It illuminated the entire forrest with a white light. The object itself had a pulsing red light on top and a bank(s) of blue lights underneath. The object was hovering or on legs. As the patrolmen approached the object it maneuvered through the trees and disappeared. At this time the animals on a nearby farm went into a frenzy. The object was briefly sighted an hour later near the back gate. 2. The next day, three depressions one and a half inches deep and seven inches in diameter were found where the object had been sighted on the ground. The following night (29 Dec 80) the area was checked for radiation. Beta/gamma readings of 0.1 milliroentgens were recorded with peak readings in the three depressions and near the center of the triangle formed by the depressions. A nearby tree had moderate (.05-.07) readings on the side of the tree toward the depression. 3. Later in the night a red sun like light was seen through the trees. It moved about and pulsed. At one point it appeared to throw off glowing particles and then broke into five separate white objects and then disappeared. Immediately thereafter, three star like objects were noticed in the sky, two objects to the north and one to the south, all of which were about ten degrees off the horizon. The objects moved rapidly in sharp angular movements and displayed red, green and blue lights. The objects to the north appeared to be ecliptical through an 8 by 12 power lense. They then turned to full circles. The object to the south was visible for two or three hours and beamed a stream of light from time to time. Numerous individuals including the undersigned, witnessed the activities in paragraphs 2 and 3

Signed CHARLES I HALT, Lt, Col, USAF Deputy Base Commander

40

the following personall were assigned at the joint RAF base of Bentwaters/Woodbridge during the Rendlesham forrest incidents of Dec 27th and 30th 1980
Lt, Col, Charles I Halt now Colonel Colonel Jack Cochran left in 1984 around spring
Colonel now Brig, Gen, Ted Conrad left in left in 1981
Colonel Sam Morgan left in 1981
Colonel now Brigadier General Gordon Williams left in Jan 81
Major Malcolm Zickler left in jan 81
Captain Kathleen McCollom left in Jan 84
Colonel Soya left in jan 81
Sergeant Adrian Bustinza Jan 81
Airman 1st Class John Burrougs left in Jan 81
Airman 1st Class Steve Wilkins left possibly in Jan 81
Airman 1st Class Art Wallace Left in Jan 81 not his real name and he is no longer in the USAF now a civillian also on record by authors of Sky Crash A Cosmic Coverup
Airman !st Class James Archer left in Jan 81 witnessed UFO on Dec 27th 80 not his real name is on record of the authors of the book Sky Crask A Cosmic Conspiracy by Brenda Butler Dot Street and Jenny Randles
Airman 1st Class Steve Roberts Security police patrolman witnessed the first sighting of Dec 27th 80 not his real name is known by the authors of Sky Crash A Cosmic Coverup

Squadron Leader Donald Moreland British RAF base Commander during the UFO events
Brigadier General Richard M Pascoe 25th Air Division left in spring of 84
the following reports of the Rendlesham forrest incidents was was recieved from a person who was stationed at Bentwaters RAFB during the second UFO event of 30 Dec 80 this person has asked the authors of Clear Intent not to use his real name so for the record he will be refered to as Art Wallace this is his view of the events typed exactly as printed on pages (214,215,216,217) of the Book Clear Intent Art Wallace was attached to the Bentwaters Air Force Base as a Security Policeman. He had ben assigned to the base for only a short period of time when at 1:00 A.M. on the night either on or near to 30 Dec 80 Airman Wallace was on duty at the Bentwaters flight line, a jeep pulled up. Two men a sergeant and a lieutenant, told Wallace to get in because they were going over to the motor pool. On the way over, Airman Wallace and the sergeant were told to get gas powered "light-alls" (trailer mounted lights used to illuminate large areas). The lights were attached to the jeep, and the Bentwaters main gate where they met other vehicles. The convoy moved out toward the Rendlesham forrest a few miles away Airman Wallace heard radio chatter mentioning names of people he knew plus OSI most likely a referance to the Air Force Office of Investigations. Airman Wallace saw security police as well as members of the British Military stationed all along the way. They pulled onto a dirt road and drove about a mile into the Rendlesham Forrest, stopping at Airman Wallace referred to as a staging point. The men were ordered to check their weapons in since they would not be taking them along Airman Wallace went into the woods with four other men led by a captain who had met them at the Bentwaters motor pool. As they approached a clearing in the woods, they noticed a brightness in the distance and the sound of helicopters overhead. Wallace noticed an airman crying at the edge of the clearing with a medic attending him. This puzzled Airman Wallace as he couldnt imahine what might have been going on. The first thing the men noticed when they had a clear view view was the large movie cameras had been placed surrounding a field in the clearing. Many plainclothes personel were milling about watching something. The something was an object taking the appearance of a transparent aspirin tablet, hovering about one foot off the ground. Airman Wallace estimated that the object was fifty feet in diameter and had a bright, pulsating, yellow mist inside it. It did not move from its position.

Airman Wallace and some of the men approached the object to within ten feet. Two down in the field would come over to the object according to Airman Wallace, appeared to be just staring at the object, oblivious to the security men in the area. A radio call was heard over a field radio unit. A helicopter pilot said, here it comes. In the distance a red light appeared first behind a pine tree, then in front of it. The light quickly sped over to the aspirin shaped object and hovered at a position about twenty feet above it. After maintaining this position for a minute, the red light broke up. No explosion occurred in the conventional sense. The light merely broke up into a shower of particles. Suddenly, in the place of the red light and the aspirin shaped object another vehicle appeared. Airman Wallace said it was a domed disc, bright white in color, with an intricately detailed surface much like the models used in movies like "star wars" and "close encounters". It had two appendages on the lower flange of the disc which seem to be the beginning of delta wings but not quite. Shadows were cast on the surface of the disc by some of the raised relief detail. Airman Wallace and the men with him walked around the object and noticed some interesting effects. Their own shadows were cast onto the object, probably by the bright "light balls" in the field. Not only did their shadows bend upwards at the head but as they walked and stopped, the shadows would appear to advance one pace more than stop. Stunned and disbelieving of this effect, Airman Wallace and the others walked and stopped several times, each time noticing the effect repeat itself. Additionally, the third time that they tried this a light came over the head of a shadow and moved from one head to another. Under hypnosis Wallace found his memory extending beyond the point where the 'TV video light' danced on the side of the UFO. He now saw aliens. Wallace describes them clearly. There were three and their height was about three or three and a half feet. Their heads were large and out of proportion to their bodies. Their eyes were like inverted cat's eyes, and the ear, nose and mouth were all just slits. Two wore all over silver suits-like an overall-the other, who seemed to be the leader, wore a similar suit but blackish. He also had what looked like a long stick by his side. It was apparently clinging to the suit, but their did not appear to be any belt or fastening. The three aliens floated from the underside of the craft and onto the ground. Still in a floating motion the one in black moved towards Gordon Williams, who Wallace insists was close to the craft. He heard no words exchanged, but saw what might have been sign language. Whilst this was happening there seemed to be a disturbance over the far side of the craft. It was out of view and so Wallace could not see what was occurring, but he could tell from the reaction of the men that something. And the aliens appeared to react too. Their eyes were normally very small but at this point they responded by enlarging them. They swelled up into big circles and then returned to normal. After a few moments the contact with Williams proceeded. Wallace was aware that the aliens had damaged their craft and that assistance was being offered in its repair. But he was simply mesmerized watching the conversation. Then one of the other two aliens began to float over in the direction of the group of men of which Wallace was one. Oh my god he's coming over to us Wallace recalls shouting. And then even the hypnosis could produce nothing beyond blackness, until the reawakening in the barracks. The debriefing occurred that day following the night UFO encounter. Wallace was picked up on base by a black car with dark glass. He could not see where he was going, he felt as if he were dragged because they made him get in and he did not want to. He felt very strange. The two men wore dark suits and looked oriental. Neither spoke when he demanded to know where they were taking him. But he felt a voice in his head say, 'Don't be afraid.' After getting out of the car at an unknown location in the dark, Wallace was led down several flights of steel stairs. He was now in a large room which housed the UFO, identical to the one he had seen in the forest the day before. But he was hastily led away from here into another room where several other men he recognized from the encounter were present. Everywhere around him was spotless and clean, like a hospital. An officer then spoke verbally and told him not to worry as all would be explained. But he then feels he lost consciousness again as his next memory is of waking up and being given breakfast. After the food he was taken to a room where there were rows of chairs and a small platform with a big screen on it. Seven men including himself, were sat there. All had been out in the forest that night. An officer, whom Wallace did not recognize, then onto the platform and explained that they were about to see some film and be informed as to why they were there.

The film was a collection of movie clips apparently taken from aircraft. They showed UFOs in pursuit of military planes and spanned many years, beginning with Second World War footage. One scene was of a craft in a huge hangar somewhere. After the show the lights came on and nothing was said. Wallace felt very calm and relaxed and again as if he were drugged. But through a glow shining at the back of the screen he saw a small figure. It was only in silhouette, masked by the material, but it was evidently an alien! The alien proceeded to explain who it was, where it came from and why it was on earth. This it did straight into Art Wallace's mind no words were spoken. Wallace could not recall the name or origin of the alien, ever under hypnosis. But he could remember the reason supposedly offered for its visit. The aliens were here to educate mankind. But only certain people had been selected to receive this knowledge. The seven men in the room were some who had been chosen. Others had been chosen before and there were a number of aliens doing similar things elsewhere. They had been on earth for a very long time, watching over and guiding the human race. Great changes were due soon. Some had happened already. Others were to come and Wallace and the others intended for intended for the purpose, would have a big part to play in these. More information would be given when these changes came closer. But they should have no no fear, because the aliens were going to watch over their their proteges now this version has a high degree of strangeness in the explanation of why the aliens had allegedly made contact with Wallace I believe this view should be taken with a grain of salt or several grains of salt I believe it highly possible for some contact in the future between humans and some alien intelligent life forms but the way that might occur is another area for discussion the Wallace version is not acceptable in my view of reality I don't think such a meeting could possibly take place under those circumstances perhaps in some distant time we may meet alien intelligent life forms but we need more time to develop our world space exploration programs perhaps more world cooperation in space will lead to more advances in space exploration but until then we can be satisfied for the present that there are possible intelligent life forms out there we only have to get there and I believe with our shuttle program we are in the right direction this space program gets several countries involved in various projects that benefit everyone involved this is a very good step in achieving long term space research goals that will eventually lead to some possible future contact with alien life forms either below or at our level or much higher in intelligence than the human occupants of the water planet earth as far as the UFO phenomena is concerned there many interesting theories as to why alien life forms as some of the close encounter cases that are well researched seem to point to some interest in our planetary biology and the varied life forms that inhabit our planet including but not exclusively humans I think that if a scientist does research on a lower form of intelligent life his standard rule might be not to alter the conditions of that given species in the process of doing his biological research so that true scientific studies can be conducted on that particular biological life form this does not seem to be the case in the UFO contact cases the aliens are only partly successful in their endeavor to allegedly conduct their human study the more documented case histories indicate the persons allegedly abducted are able to remember their abduction with the assistance of specialized hypnosis regression thus their presence has become known to persons in addition to the alleged person abducted by the aliens this conflicts with our own ideas of and experience of what happens when superior intelligence contacts lower forms of life the results are usually very unfortunate the lower form of life usually loses his identity his culture something like when the predator prey scenario when the predator is virtually eliminated with his natural enemy gone his balance of population overproduces the unplanned introduction of pest control methods can lead to a unbalance in nature so the natural means that exist do work as with humans if we made an uncontrolled contact with a vastly superior intelligent life form many thousands of years in advance of our selves the consequences might destroy our civilization and culture and result in the destroying of any human nationalities that we have today so planned contact with humans is possible but limited contact at best is the best approach at the present



MINISTRY OF DEFENCE
MAIN BUILDING WHITEHALL LONDON SW1A 2HB
Telephone 01-218 2394 (Direct Dialling)
01-218 9000 (Switchboard)

74
file
12/2/1

PARLIAMENTARY UNDER-SECRETARY OF STATE
FOR THE ARMED FORCES

D/US of S(AF)DGT/6210

19 June 1985

Dear Peter,

You wrote to Michael Heseltine on 1 May 1985 about the sighting of an unidentified flying object near RAF Woodbridge in December 1980. Michael has asked me to reply as UFO questions fall within my responsibilities.

I do understand your concern and I am grateful to you for having taken the trouble to write. I do not believe, however, that there are any grounds for changing our view, formed at the time, that the events to which you refer were of no defence significance.

You may recall the House of Lords debate on UFOs in 1979 (Hansard, 19 January 1979). I attach an extract of what I said on that occasion. Whilst I respect the views of those who differ from me on this matter I am bound to say that nothing I have seen since then has led me to change the views I myself expressed.

Yours,
David

Lord Trefgarne

Admiral of the Fleet the Rt Hon Lord Hill-Norton GCB

44

E13

Reference.....

12/4 copy to: 12/2/14

M5

APS/US of S(AF)
through Sec(AS)2 [REDACTED]

1. US of S(AF) will recall recent correspondence on this matter with Lord Hill-Norton and Rt Hon Merlyn Rees MP. In both cases he took the line that we have nothing to add to what had already been said on the Woodbridge incident. Indeed, this was the line taken in previous correspondence with David Alton (See M3). The enclosed draft reply to Mr Alton once more follows this approach.
2. Mr Alton specifically requested a copy of the MOD official reply to [REDACTED] last letter. This is enclosed, together with an earlier letter to which it refers. There is no objection to passing this correspondence to Mr Alton.
3. You may wish to note that Mr Alton has apparently passed on both letters sent by Lord Trefgarne on 19 March 85, even though one of these was intended to be for his information only.

12 June 1985

[REDACTED]
Sec(AS)2
MB 8245

45

DRAFT

D/US of S(AF)/DGT 5173

June 1985.

Thank you for your letter of 16 May to Michael Heseltine enclosing one from [REDACTED]. You asked to see a copy of the Department's reply to [REDACTED] letter of 25 February 1985 and this is enclosed, together with earlier correspondence to which it refers.

As I pointed out in my letter of 19 March, the MOD concerns itself only with the defence implications of reported UFO sightings. In this context, the report submitted by Col Halt in January 1981 was examined by those in the Department responsible for such matters and, as I have made clear in the past, it was considered to have no defence significance. We have since seen nothing to alter this view and there is nothing I can usefully add to the comments made in Sec(AS)'s letter or [REDACTED].

Lord Trefgarne

David Alton Esq MP

Job No 2-24

46



HOUSE OF COMMONS
LONDON SW1A 0AA

16th May 1985

Dear Michael,

I enclose a letter I have received from [redacted] following on from enquiries I first raised with your Department in March.

I read [redacted] letter with great interest and it seems to me that the points he raises are quite reasonable and merit a reply. I should be most grateful if you could let me have your comments and if you could let me see a copy of the reply to [redacted] own letter to your Department dated 25th February 1985.

Yours sincerely,

David Alton.

David Alton, MP.

The Rt. Hon. Michael Heseltine, MP.
Secretary of State
Ministry of Defence
Main Building
Whitehall
London SW1 2HB

47

14th May, 1985

David Alton, Esq., MP,
House of Commons,
Westminster,
London SW1

Dear Mr. Alton,

[REDACTED] has kept me informed about her correspondence with you on the unusual incidents which were reported to the Ministry of Defence by USAF authorities at RAF Woodbridge in January 1981. I have also seen Lord Trefgarne's letters to you of 19th March.

[REDACTED] decided to write further to you about this puzzling and disquieting case, and she referred to me her enclosed letter of 31st March, which is addressed to you, in the hope that I might be able to add useful comments. Much to my regret I have had to spend much time out of London on other business in recent weeks and it is only now that I am able, very belatedly, to send on [REDACTED] letter to you.

My own background, in brief, is that I served in the Ministry of Defence from 1949 to 1977, leaving in the grade of Under Secretary of State. From 1969 to late in 1972 I headed a Division in the central staffs of the MOD which had responsibilities for supporting RAF operations. This brought me into touch with a proportion of the many reports which the Department receives about unidentified traces in British airspace.

I believe that [REDACTED] is right to remain very dissatisfied with the official line which the MOD has adopted on the Rendlesham Forest incidents of December 1980. I have myself said so on a number of public occasions, and I have pursued the matter in correspondence with the MOD - wholly without success.

At the risk of burdening you with an excessive amount of paper, I attach the most recent of my letters to the Ministry of Defence. You will see that this is dated 25th February 1985. I have so far received no answer, despite reminders. On a previous occasion it took the Department three and a half months to send me a wholly perfunctory reply.

[REDACTED] claims much collateral evidence for her own views; on this I am not competent to comment. My own position is, quite simply, that an extraordinary report was made to the Ministry of Defence by the Deputy Base Commander at RAF Woodbridge early in 1981; that the very existence of this report was denied by the MOD until persistent researchers in the US secured its release under the American Freedom of Information Act in 1983; and that the MOD's responses to questions since that time have been thoroughly unsatisfactory.

I cannot accept Lord Trefgarne's view that there is no Defence interest in this case. Unless Lt.Col. Halt was out of his mind, there is clear evidence in his report that British airspace and territory were intruded upon by an unidentified vehicle on two occasions in late December 1980 and that no authority was able to prevent this. If, on the other hand, Halt's report cannot be believed, there is equally clear evidence of a serious misjudgement of events by USAF personnel at an important base in British territory. Either way, the

case can hardly be without Defence significance.

The dates in question are now rather remote, but I doubt that this should be taken to excuse the very perfunctory manner in which Lord Trefgarne has dealt with your letter. I hope that you may feel able to pursue the matter further, either in correspondence or in a PQ. The essence of the questions to be pressed seems to me to lie in my preceding paragraph. Seen in these terms, [REDACTED] article in the GUARDIAN (which Lord Trefgarne rather surprisingly falls back upon) is wholly irrelevant. If the USAF really are capable of hallucinations induced by a lighthouse which must surely be very familiar to them, then I shudder for that powerful finger which lies upon so many triggers...

My own letter to the MOD (enclosed) raises other more detailed questions. But I do not suggest that you should necessarily concern yourself with them, anyway at this stage. It would be nice if the MOD would answer letters, of course ! But the essence of the Defence interest which I suggest a responsible Member of Parliament might reasonably raise lies in the argument I have tried to present above.

If I can be of any assistance in discussion with you, I am at your disposal.

Yours sincerely,

[REDACTED]

31 March 1985

Dear Mr Alton,

Thank you for your enclosures (undated) which reached me on 30th inst.
May I comment on the reply of Lord Trefgarne to yourself.

His letter is virtually a word-for-word repeat of the standard MoD line (it must save money to keep churning them out of the word processor!) However, he does add a couple of points not previously noted. These are the specific references to not covering up "any incident or mishap" and not "in any way to obscure the truth". That said, and it presumably being true, I would have thought that it was of interest to know from the MoD why they only have the memo from Col Halt (and note he is referred to in Trefgarne's letter as Colonel Halt, his rank now, although on the memo he is Lt.Col.).

Bear in mind that this incident (whatever it was) occurred on BRITISH soil (not base land) and just outside the perimeter fence of an RAF owned base. Consequently British citizens have a right to expect to have been kept informed of matters, especially as then British commander (Squadron Leader Donald Moreland) was specifically on base for that purpose.

YET - according to the MoD stance - we are lead to believe the following data was at no time made available...VIZ

(i) The tape recording made by Halt, the base security chief and several other senior officers, which describes in detail the taking of soil samples, tree samples, photographs, radiation readings, infra-red readings etc AT THE SITE ON BRITISH SOIL. Subsequently (as the tape records) a "UFO" reappeared. This tape is in our hands and Moreland personally told me in January 1984 (several months before we got it from the US commander in America) that he was aware of its existence.

How come the MoD have no copy? How come the activities recorded on it took place on British soil without MoD knowledge? How come Moreland never advised the MoD of this vital evidence?

(ii) The photographs and samples recorded on the tape (which is officially accepted as genuine by the US) are, again, crucial evidence. Under a recent Freedom of Information (US) request they have been admitted and are likely to be made available in the USA very shortly. Again, I think we are entitled to ask why the MoD appear not only to be unaware of these but have no copies or copies of the analysis results which must accompany them. Again Moreland was aware that these samples and photographs were taken

as the MoD contend, the events do not bear any relationship to a secret test or experiment (and if they do they have lied both to you, as an MP, and to me) then that is an admission that they involve an Unidentified Object (which is all I contend the UFO to be). Indeed in the letter to me of 13 April 1983 DS 8 do say that the lights are unidentified and have "no explanation".

It seems to me that there are questions here concerning the inter-relation between the US Air Force on British soil and our country IF, as contended, several senior officers from a USAF base can be involved in protracted work outside the base and on British land without such facts being known by the MoD or the results of their work being made available.

It is an interesting question as to who legally owns the samples of allegedly

irradiated soil and tree bark taken from BRITISH land (owned by the Forestry Commission in fact): I doubt very much that the USAF have carte blanche approval to do what they like on our shores. And if they do I for one am very concerned about it!

Finally, you will note that the official response makes no reference to the lighthouse, normal background radiation theories propounded by Ian Ridpath in the Guardian (on the strength of almost no evidence). Yet the Trefgarne letter to you does try to convince you this is the answer,

Neither the MoD nor the USAF will accept the lighthouse theory officially because they are as well aware as I am that it is easily refutable by the facts. Ian Ridpath actually stated on television (in a debate with myself) (5 March 1985) that he regarded his investigation as more objective. His investigation, as he admitted, has consisted of interviewing not a single one of the 17 eye-witnesses from the USAF now traced as being present during the events. Instead it consisted of speaking to one forestry worker who found some holes in the ground one month after the sightings and has presumed they might have been connected! I have spoken to that worker also, on the site itself, and he is less than convinced of his theory himself.

None of this takes into account the various BRITISH CIVILIAN eye-witnesses who saw the events, some in positions where it is literally impossible to see the lighthouse, others looking in the opposite direction from it, and one who had the decidedly curious experience of the "lighthouse" flying right over the top of his house!

I am trying to force no explanation onto anybody. But frankly the lighthouse idea is utterly ridiculous and the MoD must know that.

Besides which - what does it do to the USAF/RAF/MoD inter-relationship if all these senior officers (base commander, deputy commander, chief security officer, on-duty night command officer and control tower chief amongst them!) do not know what a lighthouse looks like, which has stood five miles from one of our bases for decades and still stands today?

It seems to me this proffers defence implications should these men (or men like them) ever be put into a situation where they have to defend this land!

In connection with which comes the question of the radiation. Ridpath insists this was ordinary background stuff. The forest was not irradiated, The "peak" readings in the alleged ground traces (samples taken) are quoted as seven-tenths on the point five scale. And I am reliably informed these are significant.

But again - assuming they are not - are we to take it that none of these senior USAF officers have received any training in radiation monitoring? If so - are YOU satisfied to leave them in charge of cruise missiles and nuclear weapons on our shores?

I know that I am not happy, and I am convinced that such factors pose even more serious defence implications than if a genuine bona-fide UFO was involved. The MoD have steadfastly refused to make any comment on these matters. Perhaps you, Er Alton, can get them to do so?

I pass this letter to Ralph Noyes for forwarding to you, with a letter I trust he will write you. Ralph, as former head of the DS 8 section handling UFO enquiries, knows the situation better than I . . . , supports our call for more information on this affair, and will I hope open your eyes to the truth about what is being obscured here.

Please do not be put off. There are important civil liberties issues at stake.



PARLIAMENTARY UNDER-SECRETARY OF STATE
FOR THE ARMED FORCES

Telephone 01-218 2394 (Direct Dialling)
01-218 9000 (Switchboard)

WHITEHALL LONDON SW1A 2HB C12

file 12/4
copy to 12/2/d

D/US of S(AF)DGT 4884

11 June 1985

Dear Mr Rees,

Thank you for your letter of 14 May which enclosed a further letter from [redacted]

I am afraid I have little to add to what I said in my letter of 20 February 1985 in reply to your original enquiry on this matter. We remain satisfied that the events reported by Colonel Halt on 13 January 1981 are of no defence significance. The report was, like all other UFO reports, examined at the time by those in the Department responsible for the air defence of the UK and we have since seen nothing to alter our views.

Turning to [redacted] request for copies of all UFO reports we have received since 1980, I am afraid that the Department could not justify the effort involved in acceding to this request. However, [redacted] will already know that we are prepared to release reports of specific incidents to interested parties and, if he has any particular reports in mind, [redacted] can obtain copies of these from Sec(AS)2 in my Department, whose address is room 8249 Ministry of Defence, Main Building, Whitehall SW1A 2HB.

Yours sincerely,

Trefgarne

Lord Trefgarne

Rt Hon Merlyn Rees MP

D/O Air Del 13/6/3-909

From: GE3

To: Sec (AS) 2a

Subject: UFO FIGHTING 27 Dec 80

file
12/2/1
811

1- We discussed and I agreed to forward copies of relevant correspondence

2- Regrettably, the tasking letter from Moss referred to an incident on 29 Dec 80, therefore the replies from Nextidea and Eastern ladies are probably worthless. Unit radar recordings are not held for 4 years consequently we are back where we started!

31⁵.



G T KEITH
Wg Cdr
GE3
MB 4209 6528 MB



Royal Air Force
Neatishead Norwich Norfolk NR12 8YB
Telephone NORWICH 737361 ext 7-413

36

Please reply to the Officer Commanding
Your reference

MOD (Ops(GE)2b(RAF))

Our reference NEAT/12/1/AIR

Date 3 Feb 81

UNEXPLAINED LIGHTS

Reference:

A. D/DD Ops (GE)/10/8 Dated 26 Jan 81. - E26

1. At Reference A you asked us to provide a statement of radar observations, or lack of them, regarding a reported sighting of airborne phenoma on the evening of 29 Dec 80.

2. I regret that, in accordance with local procedures, our radar camera recorder was switched off on cessation of normal flying activities at 1527Z on 29 Dec 80. An examination of executive logs revealed no entry in respect of unusual radar returns or other unusual occurrences.

S D SHARPE
Sqn Ldr
for OC

MINISTRY OF DEFENCE
- 9 FEB 1981
HQ OPS (GE) RMP

RESTRICTED

02/3/Air

Eastern Radar
RAF Watton



Watton 881691 ext 200

MOD(Air)
Ops (GE) 2b (RAF)

26 Feb 81

UNEXPLAINED LIGHTS - RAF BENTWATERS

References:

- A. Telecon Sqn Ldr Coumbe/Sqn Ldr Badcock 23 Feb 81.
- B. D/DD Ops (GE)/10/8 dated 26 Jan 81.

1. At Reference A we confirmed that the film of the reported sighting in Reference B was at fault. We have now developed the film on the days prior to and after the reported phenomena - regrettably both films were also faulty.
2. On the night of the reported sighting our controller on duty was requested to view the radar; nothing was observed. The facts are recorded in our log book of that night

E26

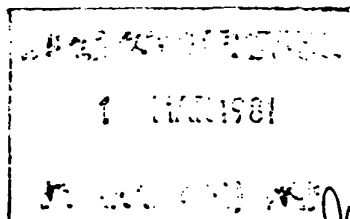

D J COUMBE
Sqn Ldr
for OC

RESTRICTED

7274

RAF Neatishead
Eastern Radar
RAF Watton

~~FILE~~
26

D/DO Ops(GE)/10/8

26 January 1981

UNEXPLAINED LIGHTS

1. The Deputy Base Commander of RAF Bentwaters has reported sightings of airborne phenomena on the evening of 29 Dec 80 in the Roudlesham forest area near Woodbridge. We would appreciate a statement of radar observations, or lack of them, in the area and at the time concerned.

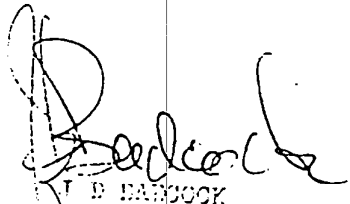

J. B. HARRIS
Squadron Leader
Ops(GE)26(RAF)

RESTRICTED

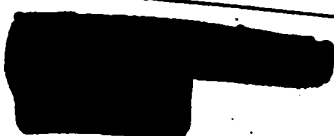

MINISTRY OF DEFENCE
Main Building Whitehall London SW1A 2HB

Telephone 01-218 (Direct Dialling)
01-218 9000 (Switchboard)



Your reference

Our reference

D/Sec(AS)12/3 ✓

Date

15 May 1985



Thank you for your letter of 25 February 1985, addressed to Brian Webster who, as I believe you now know, has left this division (now Sec(AS)). I am sorry that I have not been able to reply before now. Thank you also for sight of the extracts from your proposed book.

In his letter of 20 March 1984, Brian Webster explained the MOD's position regarding Colonel Halt's reports on events near RAF Woodbridge in 1930, and I have little to add to the views Brian expressed. I know from your letter that you are well aware of the limited extent of the MOD's interest in the subject. Nonetheless, there are, perhaps, one or two points which I should make. Firstly, whilst I cannot, of course, comment on the proportion of UFO sightings which are not reported, I can assure you that those which are reported to local police forces and to the Civil Aviation Authority should all be passed on to this division of the MOD. We treat all these reports seriously in case they show anything of defence interest. However, we have never found any reason to believe that, in the defence context, such reports warrant more detailed research. Equally, since our interest extends only as far as defence of the UK, there has never been any formal liaison with other Governments.

Turning to your specific questions about the Woodbridge incident, I can assure you that no unidentified object was seen on any radar recordings during the period in question, and that the MOD has no knowledge of the tape-recording or cine film you mention. As we have said in the past, the report sent by Colonel Halt was examined by those in the Department responsible for the air defence of the UK and since then there has been nothing to alter the view that there was no defence significance to the incident.

Yours sincerely

Ministry Of Defence
Whitehall London SW1A 2HB

November 12.1984

Dear Sir:

I am an american investigator of the u.f.o. phenomena. The involvement of my wife and myself with the phenomena is well documented in two books published in the U.S. The books are (The Andreasson Affair) and (The Andreasson-Affair Phase Two) published by Prentice Hall Publishing of New Jersey. Because of our experiance with the u.f.o. craft and occupants we seek the truth with regard to the whole phenomena in it's entirety.

It is for this reason I write you. I am aware of the report our Air Force OSI completed and sent to your agency concerning the landing of a "craft of unknown origin crewed by several entities near RAF Bentwaters on the night of December 29/30 1980". I would appreciate any information you could send me regarding this incident, especially what is refered to as Flag A and on original reports Flags B-C which states the landing is not considered a defence issue in view of the overt peaceful nature of the contact. The report further states this is part of a series of landings to SAC bases in the U.S.A. and Europe. Any help you can provide concerning this situation would be greatly appreciated.

Thank You



Defence Secretariat 8 Room 7230
MINISTRY OF DEFENCE
 Main Building Whitehall London SW1A 2HB
 Telephone 01-218 (Direct Dialling)
 01-218 9000 (Switchboard)

12/2/1

REPORT OF SIGHTING -
 BRIDLESHAM FOREST
 DECEMBER 1981

[Redacted]

Your reference

Our reference

D/DS 8/10/209

Date

28 November 1984

[Redacted]

I have seen the alleged report of a 'UFO' landing near RAF Bentwaters which you referred to in your letter, but I am afraid that it is a forgery. Although apparently written on official Ministry of Defence paper (I have only seen a photocopy), it is most certainly not an official document and its contents bear no relation to our policy towards reported sightings of 'Unidentified Flying Objects'. Obviously I have no idea where it came from or why it was written and can only conclude that it was intended by someone as a joke.

In fact, our interest in reported sightings of 'UFOs' is very limited. We are concerned solely with whether these reports reveal anything of defence interest, such as intruding aircraft and if we are satisfied that they do not we take our investigations no further. There is no organisation in the MOD appointed solely for the purpose of studying UFO reports and no staff are employed on the subject full time. The reports we receive are referred to the staff responsible for the air defence of the United Kingdom, who examine them as part of their normal duties.

We did receive a report by Col Charles Halt of the USAP, of some lights seen outside RAF Bentwaters in December 1980, I attach a copy, although you may well have already seen it. The Department satisfied itself at the time that the lights were of no defence significance and took matters no further. We did not attempt to identify what might have been seen, but I can assure you that there is no evidence whatsoever that anything intruded into British airspace or landed outside RAF Bentwaters.

I hope you find this helpful.

Yours Sincerely,
 J. Hattersley



MINISTRY OF DEFENCE
Main Building Whitehall London SW1A 2HB

Telephone 01-218 (Direct Dialling)
01-218 9000 (Switchboard)

Your reference

Our reference
D/DS8/10/209

Date

14 September 1984

[REDACTED]

Thank you for your letter of 18 July.

I should first of all point out that the sole interest of the Ministry of Defence in reported sightings of Unidentified Flying Objects (UFOs) is to establish whether they have any bearing on the defence of the country.

There is no organization in the Ministry of Defence appointed solely for the purpose of studying UFOs, and no staff are employed on the subject full time. The reports we receive are referred to the staff in the Department who are responsible for the air defence of the United Kingdom, and they examine the reports as part of their normal duties.

Since our interest in UFOs is limited to possible defence implications we have not carried out a study into the scientific significance of these phenomena. Unless there are defence implications we do not attempt to identify sightings and we cannot inform observers of the probable identity of the object seen. The Department could not justify the expenditure of public funds on investigations which go beyond the pure defence interests.

The only information we have on the alleged "UFO sighting" at Rendlesham Forest in December 1980 is the report by Colonel Charles Halt, of the United States Air Force, of lights seen outside RAF Woodbridge. A copy of this is enclosed. We are satisfied that the events described are of no defence significance.

I am also enclosing with this copies of 2 recent Parliamentary Questions, which you may be interested in.

Yours Sincerely

[Handwritten signature]

E9

25 JUL 1984
10/2091

[REDACTED]

18/July/84.

Dear Sir,

I am sending this letter with ref to my interest in the events surrounding the Rendlesham Forest UFO incident in Suffolk Dec/80. I am studying this case, as it is of some significance. And I would be obliged if you could send me some additional information regards this incident?
As I was informed by a certain person that some files on the Rendlesham case had been despatched to investigators involved etc, via freedom of information act.
hoping you are able to reply.

Yours sincerely,

[REDACTED]

[REDACTED]



RAF LIAISON OFFICE *file 10/201*
 Royal Air Force Bentwaters Woodbridge Suffolk IP12 2RQ

Telephone Woodbridge 3737 ext 2557

No Action

Mr P D Watkins
 Defence Secretariat Div 8d
 Ministry of Defence
 Main Building
 Whitehall
 LONDON
 SW1A 2HB

Your reference

Our reference

BENT/C/AIR

Date

21 August 1984

Dear Peter

Further to my telecon of yesterday I enclose a copy of the request from 'Cable News Network' on information concerning our "UFO" incident of 1980.

At the moment I have no involvement but I would not be surprised to find the British interest revived.

Yours

Peter Crowl

RCV MSG # TIME RADAY
0232 1618 233/84

ANY CASUAL TELEPHONE CONVERSATIONS CAN REVEAL CLASSIFIED INFORMATION THROUGH CARELESSNESS - IMPATIENCE - AND TRYING TO TALK AROUND.

E2
IMMERI

0200ZUW RHFGAAL087 2331616-UUUU--RUDOVJA.

ZNR UUUUU

Q P 201700Z AUG 84

FM HQ USAF RAMSTEIN AB GE//PAM//

TO RUDOVJA/RTFM RAF BENTWATERS UK//PA//

INFO RUDOVFA/3AF RAF MILDENHALL UK//PA//

BT

UNCLAS

SUBJ: QUERY FROM CMH TO RE UFO SIGHTING(S)
1 REFERENCE TELECOM BETWEEN MAJ MCCOLLISTER, HQ USAF/PAM, AND CAPT W-RZINSKI, RTFM/PA, 20 AUG 84, SAME SUBJ.
2 OSAF/PAM HAS RECEIVED A WRITTEN REQUEST FROM CHUCK DE CARO OF CABLE NEWS NETWORK FOR INFORMATION ABOUT AN ALLEGED UFO SIGHTING AT RAF BENTWATERS ON 27 DEC 1980. THE CMH REPORTER HAS A COPY OF A LETTER DATED 13 JAN 81 FROM THE THEN-DEPUTY BASE COMMANDER AT RAF BENTWATERS WHICH REPORTS ON THE INCIDENT. THE 13 JAN 81 LETTER WAS ADDRESSED TO 3AF/CC. OSAF/PAM HAS ASKED US TO HELP THEM RESPOND TO SOME 20 QUESTIONS POSED BY CMH. WE NEED YOUR ASSISTANCE IN FLESHING OUT THE RESPONSES. WOULD APPRECIATE RTFM/PA, THROUGH 3AF/PA, PROVIDE US THE BEST RESPONSES POSSIBLE TO THE FOLLOWING QUESTIONS. WE WOULD APPRECIATE THE ANSWERS BY 23 AUG 84, OR SOONER IF POSSIBLE. THE QUESTIONS ARE:

PA
C.C.E
11

PAGE 2 RHFGAAL087 UNCLAS

- Q-1: EXACTLY HOW MANY UNEXPLAINED LIGHTS/SIGHTINGS OCCURRED?
- Q-2: OVER THE COURSE OF HOW MANY DAYS DID INCIDENTS OCCUR?
- Q-3: DID USAF SECURITY POLICE CORDON OFF THE AREA SPECIFIED IN LT COL HALT'S REPORT?
- Q-4: WHAT UNITS WERE INVOLVED IN THE SIGHTINGS? WERE AAVS UNITS THERE?
- Q-5: WAS THERE A HELPING HAND, COVERED WAGON, FADED GIANT OR BROKEN ARROW REPORTED OR REPORT GENERATED BY THE INCIDENT?
- Q-6: DID GEN. GORDON WILLIAMS WITNESS THE INCIDENT? IF SO, WHY DID HALT WRITE A REPORT?
- Q-7: WILL GENERAL WILLIAMS WRITE AN OFFICIAL STATEMENT ABOUT HIS INVOLVEMENT WITH THE INCIDENT FOR CMH?
- Q-8: HOW MANY USAF PERSONNEL WITNESSED THE SIGHTINGS?
- Q-9: DID SECURITY POLICE MAJOR ZEIGLER WITNESS THE INCIDENT?
- Q-10: DID SGT. JOHN BURROUGHS WITNESS THE INCIDENT?
- Q-11: WAS THERE A LIEUTENANT ENGLAND IN THE SECURITY POLICE UNIT AT RAF BENTWATERS AT THE TIME AND DID HE WITNESS THE INCIDENT?
- Q-12: WHAT ARE THE CURRENT UNITS AND DUTY STATIONS OF GENERAL WILLIAMS, COLONEL HALT, SGT BURROUGHS, MAJ BIRLEN AND LT ENGLAND?
- Q-13: WERE THERE USAF DISASTER PREPAREDNESS, EOD OR NUCLEAR

PAGE 3 RHFGAAL087 UNCLAS

- WEAPONS MANAGEMENT TEAMS DISPATCHED TO THE SIGHT OF THE INCIDENT?
- ARE THERE COPIES OF THEIR REPORTS IN USAF FILES? IF SO, WHICH UNITS HAVE THE FILES?
- Q-14: WHAT UNIT OR WHAT PERSONNEL TOOK THE RADIOACTIVITY READINGS REFERRED TO IN LT COL HALT'S REPORT? WHAT UNIT OR PERSONNEL

ESTABLISHED THE GEOMETRY OF THE INDENTATIONS ON THE GROUND? WHERE
ARE THEIR OFFICIAL MEASUREMENTS AND REPORTS?

Q-15: WERE THERE ANY NON-NATO PERSONNEL INTERVIEWED OR SEEN AT
THE SITE OF THE INCIDENT? COULD THESE PERSONNEL HAVE BEEN ASSOCIATED
WITH THE UNEXPLAINED LIGHTS?

Q-16: WERE OSI PERSONNEL DISPATCHED TO THE INCIDENT SITE? DID
OSI INTERVIEW LT COL HOLT, SGT LARRY WARREN, AIRMAN STEVEN CA PLUNE,
GENERAL WILLIAMS, MAJOR ZEIGLER, LIEUTENANT ENGLAND OR SGT BURROUGHS?

Q-17: WILL THE USAF PROVIDE A LIST OF USAF PERSONNEL WHO
WITNESSED THE INCIDENT?

Q-18: WHAT ARE THE REASONS THAT WILLIAMS, HOLT AND BURROUGHS
GAVE FOR NOT GRANTING OFFICIAL INTERVIEWS?

Q-19: ARE THERE PHOTOGRAPHS, TAPE RECORDINGS, VIDEOTAPES,
DRAWINGS OR DESCRIPTIONS OF ANY KIND IN USAF FILES? IF NOT, TO WHAT
AGENCY OR AGENCIES HAVE THE FILES BEEN TRANSFERRED?

PAGE 4 RHFQAAAL007 UNCLAS

Q-20: WERE PERSONNEL FROM CIA, DIA, NSA, USAF INTEL, OR NSC
NOTIFIED ABOUT LT COL HOLT'S SIGHTINGS? WHY? DID THE SECAF VISIT
THE BENTWATERS IMMEDIATELY AFTER THE INCIDENT? WHY? DID ANY SECAF
STAFF ACCOMPANY THE SECAF? WHO WERE THEY?

3 YOUR ASSISTANCE IN THIS PROJECT IS APPRECIATED.
BT
04007

NNNN

64



MINISTRY OF DEFENCE Rm 7230
Main Building Whitehall London SW1A 2HB
Telephone 01-218 (Direct Dialling)
01-218 9000 (Switchboard)

file

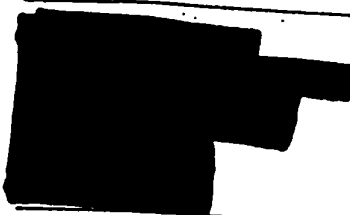

Your reference

Our reference

D/DS8/10/209-767

Date

18 July 1984



Thank you for your letter of 28 June. I am afraid that there really is very little more I can say in answer to the two main questions you ask.

We received Colonel Halt's report regarding the lights seen in Renllesham Forest, near RAF Woodbridge, and the operational staff have satisfied themselves that there was nothing in the report which gave rise to any concern from a defence point of view. In these circumstances, and I apologise if this was not quite clear in my earlier letter, we make no attempt whatsoever to establish what was seen. I can therefore make no official comment on what was seen, or try to guess what it might have been, but, as I said, there is absolutely no evidence that anything had either intruded into UK airspace or landed near RAF Woodbridge.

As to your second question, no Government Department or official body, apart from the Ministry of Defence, has any interest in these reports, and the interest of the Ministry of Defence is very strictly limited, in the way I described.

Yours Sincerely,

[Handwritten signature]

[REDACTED]

UR REF: HH/SL

UR REF: D/DS8/10/209

28th June, 1984

For the attention of A. Mathewson Esq.

Ministry of Defence,
Defence Secretariat 8,
Room 7230,
Main Building,
Whitehall,
LONDON SW1A 2HB

Dear Mr. Mathewson,

I thank you for your letter of the 19th instant with its enclosures.

If I might refer to the last paragraph of your said letter and refer you to Colonel Halt's report, of which I have a copy, you will obviously observe that of the three numbered paragraphs thereof, paragraphs numbered 1 and 2 relate to "a strange glowing object..... metallic in appearance and triangular in shape approximately two to three metres across the base and approximately two metres high.....hovering or on legs" - since you say that you have satisfied yourself that nothing in Colonel Halt's report was of significance from a defence point of view I assume that you are aware of and can explain to me what this object was.

You then go on to say that there is no evidence of anything having "intruded" into British air space and "landing" near R.A.F. Woodbridge and therefore am I to take this to mean that the vehicle referred to in paragraph numbered 1 of Colonel Halt's report has been identified by you and that you are satisfied that it was not an "intruder" i.e. it had the consent of H.M. Government, directly or indirectly, to be there?

I am sure you will take my point that there is a great deal more referred to in Colonel Halt's report than mere "lights" since the report clearly describes a substantive craft which obviously left marks bearing witness to its presence (see paragraph No. 2 of Colonel Halt's letter).

If I may be permitted to continue, I would like now to refer to the second paragraph of your letter to me wherein you state that your Ministry is solely concerned with matters of a "defence" interest, which I accept, and perhaps you would kindly confirm, as I understand to be the case, that whilst your Ministry's interest is solely in connection with anything that might be held to be a threat to our national security, there is another "wing" of Government or State, or a "wing" controlled by the Government, which does have an interest in those objects that fly about, which have no defence implications (i.e. are not a threat to national security) and which are not what the man in the street would regard as conventional aircraft, meteorite, satellite, ball lightning, comet or any atmospheric phenomena.

At this stage I hope you will not be offended of my enquiring as to whether you, Mr. Mathewson, replied to my letter from your own knowledge and file or whether the reply to me was passed from others to your good-self, i.e. is the reply yours or are you acting as a "go-between"?

OUR REF:

- 2 -

OUR REF:

I feel that I do owe you some explanation as to how and why I am involved in the subject of unidentified flying objects and I would mention that, if you can spare me another few more minutes, my interest in this subject commenced some six years ago, when, as a total cynique, I investigated a sighting in Wales for the purpose of giving a talk to a discussion group, of which I was then and still am a member, on the subject of U.F.O.'s.

I started out to prepare this talk "tongue in cheek" and, indeed my visit to Wales (actually Anglesey) was made in the same frame of mind but I have to say that I returned with a somewhat different point of view.

Since that time I have been involved, along with colleagues whose acquaintance I was to make, in the research of a small but significant number of sightings and I find that, although I have never seen anything myself, the more that I delve into this subject the more convinced I become that there is a craft of unknown origin, or at least of an origin unknown to the great mass of mankind, which flies about this planet motivated by a purpose at which I can only guess.

The questions that one has to ask oneself are to what extent does Government know more than the man in the street and conceal from him such knowledge and is one under a public duty to enlighten the man in the street not only as to the possibility of such concealed information but also as to its content?

The dilemma that one faces is whether or not it is in the interests of the man in the street to be aware of what is going on or whether it is in his interests not to know and clearly, the answer to this must depend on the reasons for concealment i.e. whether the same is in the public good and, as such, an exception from the normal rule that the public is entitled to know what is going on or whether concealment from the public is ~~not~~ in their interests since it is designed solely to protect, perhaps, limited sectional interests e.g. that of the oil industry against the introduction of a new plentiful and cheap means of fuel.

I subscribe to the "middle of the road" view that the public are entitled to know something of that which is going on but as yet cannot make a decision as to whether they are entitled to full disclosure since I have to concede that there may be wiser heads than mine who have genuine bone fide reasons for concealment, of which I may not be aware, but which are clearly in the public interest.

Much of what I have said may well be meaningless to you and I suspect it will be if you are merely replying to me from information which is passed on to you from elsewhere, and from a source to which you yourself do not have access.

However, I feel as a matter of courtesy that I owe you some explanation of my involvement in the topic of U.F.O.'s which I suspect is a relative term since what may be totally unidentifiable to one person may be partially identifiable or recognisable to another.

Finally, having outlined in short general terms my philosophy and thinking on the subject, I would be grateful to receive your specific reply

67

[REDACTED]
OUR REF:

- 3 -

OUR REF:

to the points I have raised relating to Colonel Halt's report and that Department of State which does concern itself with those craft when the same are considered not to be a Defence issue.

Thanking you in anticipation.

Kind regards.

Yours sincerely,
[REDACTED]



MINISTRY OF DEFENCE
Main Building Whitehall London SW1A 2HB

Telephone 01-218 (Direct Dialling)
01-218 9000 (Switchboard)

Your reference

Our reference
D/DS8/10/209-110

Date

13 July 1984

[Redacted]

Thank you for your letter of 4 July. I am sorry that you appear to have found my last letter, of 22 June, disappointing. However, I have nothing to add to my explanation of the Ministry of Defence's interest in so called UFO reports and I suggest that there is little point in continuing this correspondence.

Yours sincerely,
Matthews

DATE. 4th July 1984 W/L4/MD.

To/A MATHEWSON

DEAR MR. MATHEWSON,

I yet again find myself writing to you, and I'm
dissapointed this time. I recived your last letter only to find my question
Unansered and your reply was inadequate. (Totally)

① RENDELSHAM FOREST INCIDENT. After reading Col HALTS report - How did the
MOD Satisfie Thereselves that there was No Defence Implications PLEASE
Explain the conclusion and how it was reached..!

② MOD RELEASE FILES. Why Do you NOT keep to your policy As in section
3 of your letter to me dated 6th JUNE 1984. Send me ONE report file
Such as the one you released to ufologist IAN MRZYGLAD AND Author/
ufologist JENNY RANGLES. if you find you-self unable to release the file
I would like an explanation.

In your reply I would be grateful if it contained more than nine lines
of TOTAL Jargon and repeats of what you have stated in previous letters
I look forward to an half decent answer - many thanks.

Yours sincerely

[Redacted signature]

[Redacted signature]



MINISTRY OF DEFENCE DS8, Room 7230
Main Building Whitehall London SW1A 2HB

Telephone 01-218 (Direct Dialling)
01-218 9000 (Switchboard)

F.

[Redacted]

Your reference

Our reference
D/DS8/10/209-748

Date
22 June 1984

[Redacted]

I am sorry that I forgot to enclose the copy of Col Halts report with my previous letter. I am therefore including it with this. As to the remainder of your letter, we received no report of an "unidentified flying object" near Cwmbran 14 September 1982, and as I have said before we do not have the resources to search through our files for any reports we may have received from the Wigan area for a particular year. The reports we receive have so far proved to be of no interest from a defence point of view, so this would in any event fall well out of our defence responsibilities.

Yours sincerely,
A. Hatten

END:

71

-ment
title
rivate
igate
rtme
well
and
n for
orte
NOT
ited
te
eas
or
are
to
b

[REDACTED]
[REDACTED]
[REDACTED]
ur reference. [REDACTED]

ur reference D/DSB/10/209.

Dear Mr Mathewson,

Thank you for your reply to my last letter to your department
your reply to me you wrote, find enclosed a copy of Colonel Holt's report, apparently
further inspection of your reply NO report was to be found in the envelope.
Could you amend this by sending the copy to us as stated - many thanks.
Section 3 of your letter you stated, and I quote, 'We will release the details of particu-
lar specified reports on request'. Then to your policy I would like to ask on behalf of our Investigator
the MOD file investigation of the September 14th 1982 sighting at CWMBRAN, your department
reported has to covering this case by a well known UFO Association, we would be well
pleased if you could help us in anyway with this case. Here at WAPIT, we do now understand that
your department do not ATTEMPT to identify UFO's/ARIEL Phenomena unless it causes concern from
a REFERENCE point of view. Back to section 3 again, you do keep the details/files of cases reported
to you, this being the thing that interests me - if this is so - then why is this information NOT
passed over to serious investigation teams! For example, I myself on behalf of WAPIT requested
information files on certain cases such as the RENDELSHAM Forest Incident - the complete
- and all we receive is NOTHING! - then may I ask why you have a policy to CONSIDER release
of specified reports, when you don't for some reason wish to keep to this policy? OR
deliberately sway away from the GENUINE requests made? May I make it clear in NO WAY are
saying this is a deliberate sway from the so-called MOD Policy. Once more I must point out
your department do NOT investigate UFO's - so how do you know the sightings will NOT be
investigated unless files are made open to ufologists - so that they can get on with their job
of investigation and evaluation of the phenomena observed. That is why we MUST have
co-operation through all our network channels, for the ufologist to continue with a case
must obtain as much information as possible to do his job of evaluation well: (I hope you
agree with me on this point?)

May I enquire what Reports you received in 1983 for the Wigan AREA a percentage number out of the 390 you received...

May I now take time to thank you sincerely (I feel sure it is due) for the cooperation, time and consideration you have given me so far. We are Investigators of a Phenomena which at present remains Unidentified and I try very hard to keep our Investigation of the subject OBJECTIVE and detailed (which I am sure you will appreciate). Once again I thank you and the department, and I look forward to your speedy reply...

Yours sincerely





MINISTRY OF DEFENCE
Main Building Whitehall London SW1A 2HB

Telephone 01-218 (Direct Dialling)
01-218 9000 (Switchboard)

FORM 7230

File

[REDACTED]

Your reference

Our reference
D/DS8/10/209-723

Date

19

June 1984

[REDACTED]

Thank you for your letter of 4 June; I am sorry that we did not reply when you first wrote in March.

The letter you enclosed with yours is very interesting, but I have to say that it is a forgery. Although apparently written on Ministry of Defence headed paper it is most certainly not an official document and, as I shall explain, its contents bear no relation to our policy towards reported sightings of "Unidentified Flying Objects". Obviously I have no idea where it came from or why it was written, and I can only conclude that it is intended as a joke.

In fact, the Ministry of Defence's interest in reported sightings of UFOs is very limited. We are concerned solely with whether these reports reveal anything of defence interest, such as intruding aircraft, and if we are satisfied that there are none we take our investigations no further. There is no organization in the MOD appointed solely for the purpose of studying UFO reports, and no staff are employed on the subject full time. The reports we receive are referred to the staff responsible for the air defence of the United Kingdom, who examine them as part of their normal duties.

We did receive a report from Col Charles Malt of the USAF of lights which had been seen outside RAF Woodbridge. This was confirmed by John Stanley, Minister of State for the Armed Forces in answer to a written Parliamentary Question from Sir Patrick Wall MP on 24 October last year. A copy of this is attached for your information. The Department satisfied itself at the time that nothing in the report was of significance from a defence point of view. What the explanation for the lights is I do not know. However, I can assure you that there is absolutely no evidence of anything having intruded into British airspace and 'landing' near RAF Woodbridge.

Yours Sincerely,
[Signature]

74

OUR REF:

YOUR REF:

RECORDED DELIVERY

4th June, 1984

B.M. Webster Esq.,
Head of D.S.8.,
Ministry of Defence,
Main Building,
Whitehall,
London SW1.

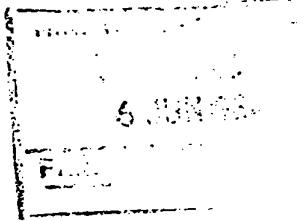

Dear Mr. Webster,

re: U.F.O. Sighting in Mendlesham Forest of December 1980.

I enclose a copy of a letter which was sent to me in January of this year, together with a copy of the front of the envelope containing the same, and would be grateful to receive your observations thereon.

Thanking you in anticipation.

Kind regards.

Yours sincerely,





MINISTRY OF DEFENCE

Main Building, Whitehall, London SW1A 2HB

Telephone (Direct Dialling) 01-218 [REDACTED]

(Switchboard) 01-218 9000

Dear [REDACTED],

As you know, OSI has completed a report on the landing of a craft of unknown origin crewed by several entities near RAF Bentwaters on the night of December 29/30 1980.

Interestingly, OSI reports that the entities were approximately 1½ metres tall, wore what appeared to be nylon-coated pressure suits, but no helmets. Conditions on the night were misty, giving the appearance that the entities were hovering above ground level.

Tape recordings were made on which the entities are heard to speak in an electronically synthesized version of English, with a strong American accent. Similar transmissions intercepted irregularly by NSA since 1975. (See attached - Flag A)

According to OSI, entities had claw-like hands with three digits and an opposable thumb.

Despite original reports (Flags B - G), OSI said the craft was not damaged but landed deliberately as part of a series of visits to SAC bases in USA and Europe. Reports that craft was repaired by US servicemen or was taken on to the base are not confirmed by OSI.

Landing is not considered a defence issue in view of the overt peaceful nature of the contact, but investigations by DS8 are to be continued on [REDACTED] authority. Precautionary plan for counter-information at a local level involving [REDACTED] and a [REDACTED], is strongly recommended.

Sincerely

[REDACTED]



MINISTRY OF DEFENCE
Main Building Whitehall London SW1A 2HB

Telephone 01-218 (Direct Dialling)
01-218 9000 (Switchboard)

Room 7250

File

(5)

[Redacted]

Your reference

Our reference
D/DS8/10/209-730

Date

19 June 1984

[Redacted]

As I have explained previously, the MOD's only interest in so called "UFO sightings" is to establish whether they reveal anything of defence interest. Once we are satisfied that they do not, we do not consider them further. In the case of the lights seen outside RAF Woodbridge, we were satisfied that there were no defence implications. If you followed the press articles on the Woodbridge incident you will have seen the results of a good deal of investigative journalism which turned up quite rational and down to earth explanations for what was seen. As I recall one favourite explanation was the light from the Orfordness lighthouse. What the truth is I do not know; as explained, we do not attempt to investigate reports to a point at which a positive explanation can be made. I can assure you, though, that there is no question of anything having intruded into British airspace and "landed" near RAF Woodbridge.

I am afraid that I cannot help you with the information you requested concerning the 8 alleged sightings in 1978. Whilst we are prepared to release individual reports if they are readily available and easily to hand we do not have the staff or resources to mount extensive searches through our records and it was never our intention to provide a research service for members of the public.

Yours Sincerely,
L. Matthews

77

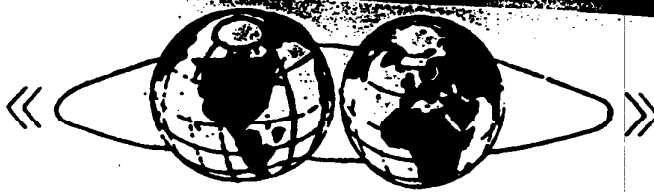

Mr A Mathewson,
Defence Secretariat 8,
Ministry of Defence,
Main Building, Whitehall
London, SW1A 2HB

Your Ref: D/DS8/10/209

Our Ref: [REDACTED]

6/June/1984

Subject: Unidentified Flying Objects

Dear Mr Mathewson,

Thank you for your letter dated 11/5/1984 in relation to my question regarding an official investigation by the MOD in response to the high level of purported sightings of UFOs in the Yorks/Lancs area.

Turning to a much more recent letter acquired by this organisation from the MOD. I would appreciate your own thoughts regarding a letter forwarded to your dept, from Col. Charles Holt, Deputy Base Commander at RAF Woodbridge. He obviously is convinced an unknown flying object was in the vicinity of the base, do you not feel that the implications behind such a statement warrant an official enquiry? I have a letter from Kathleen T McCollom, Captain, USAF, Chief, Public Affairs Division, that states, "we have no official interest in what may have happened, especially since the lights were seen off base". (17.10.83). Your letter forwarded to one of our researchers clearly proves some investigation was carried out by USAF personnel, i.e. paragraph 2.:-

"The next day, three depressions 1 1/2" deep and 7" in diameter were found were the object had been sighted on the ground. The following night (29.12.80) the area was checked for radiation. Beta/gamma readings of 0.1 milliroentgens were recorded with peak readings in the three depressions and near the centre of the triangle formed by the depressions. A nearby tree had moderate (.05-07) readings on the side of the tree towards the depressions".

I feel this is more than speculative talk, the document is ample evidence that unknown craft were operating in British Airspace. Therefore one can only reach the disturbing conclusion that the British and American Governments are aware of the nature and logic which revolves around this phenomenon.

As a member of the British public I feel the subject of UFOs should be investigated totally. 4000 CIA and American Secret establishment documents prove without a shadow of a doubt, an official interest. I think the well used phrase by the MOD

hat we are only interested in Defence implications"does not ring true. Something unknown to the base commander at Woodbridge obviously broke British Airspace, one must be perplexed at the attitude the authorities have publicly shown.

I would be interested to learn of your stance, if we aquired video footage of unknown and structured craft which clearly shows the subject image on the ground, and in this case - an UFO? It is most frustrating when we aquire actual photographs of UFOs which have been analysed by the Worlds foremost authority on computer analysis, and been classified genuine, that the British Government are taking no action.

I would now like to turn to a number of sightings which occurred between the dates of 28th May - 18th August, 1978, near the Menwith Hill (USA) listening base. We investigated no fewer than 8 reported sightings by the villagers of Darley, who I must add were very frightened. The reports were investigated by this organisation who were in constant contact with a Mr Mills, Public Relations Officer at the base. I am sure Menwith Hill forwarded a number of these sightings to MOD. The exact dates and times are as follows:

28.5.1978. 7.30pm. Multiple witnesses.
29.5.1978. 9.15pm. 1 man.
1.6.1978. 11.12pm. 1 man 1 female.
3.6.1978. 11.05pm. 1 man.
28.7.1978. 10.30pm. 5 men 5 female.
5.8.1978. 10.40pm. Multiple witnesses.
9.8.1978. 10.20pm. 3 girls (teenage).
18.8.1978. 12.30pm. 5 men 5 female.

I would appreciate any data you may have regarding the above dates, and for your comments regarding the contents of the Woodbridge letter. Thank you for your valuable time.

Yours Faithfully,

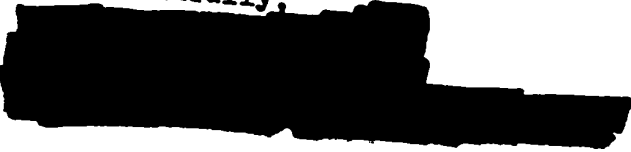



MINISTRY OF DEFENCE Room 7230
Main Building Whitehall London SW1A 2HB

Telephone 01-218 (Direct Dialling)
01-218 9000 (Switchboard)

File. (C)

Your reference

Our reference
D/DS 8/10/209-682

Date
6 June 1984

[REDACTED]

You wrote again on 16 May with further questions on the Ministry of Defence's policy towards the reports we receive of flying objects which the observer could not identify. I shall take your questions in turn.

First you asked about the number of reports we have received. For each of the years since 1978 we received the following number: 1978 - 750, 1979 - 550, 1980 - 350, 1981 - 600, 1982 - 250, 1983 - 390.

As to your second question, our policy is that we will consider releasing the details of particular, specified reports, on request, if the information is easily identifiable and readily to hand. We do not have the resources, though, to go through our files for all reports from Wigan since 1980.

Your third question concerned the lights seen in Rendel Wood Forest in December 1980, as reported by Colonel Halt of the United States Air Force. As you may have gathered from Mr Stanley's answer in Hansard of 24 October 1983, we received this report and satisfied ourselves that it contained nothing of defence interest. In case you have not seen it, I enclose a copy of Colonel Halt's report.

Finally, I explained in my previous letter that so long as there is nothing in the report to cause concern from a defence point of view (and there never has been) we make no attempt to identify what was seen.

Yours sincerely

J. H. Walters



Defence Secretariat 8
MINISTRY OF DEFENCE Room 7230
 Main Building Whitehall London SW1A 2HS
 Telephone 01-218 7230 (Direct Dialling)
 01-218 9000 (Switchboard)

file

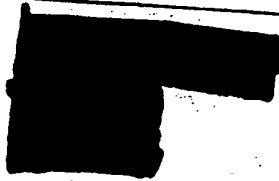

Your reference

Our reference

D/DS8/10/209-66k

Date

31 May 1984



You wrote to me again on 19 May with further questions about our policy towards reports of 'Unidentified Flying Objects'.

We receive a reports from a variety of sources, but principally from the police, RAF Stations and civil airfields. These bodies send on to us any reports they receive from members of the public of flying objects which the observer could not identify, so that operations staff here can check for possible defence implications. However, as Mr Stanley explained in his Parliamentary answer of 24 October last year, no report we have received has ever been of concern from this point of view. That includes Colonel Halt's report of lights in Rendlesham Forest.

Yours sincerely,

L. H. H. H.

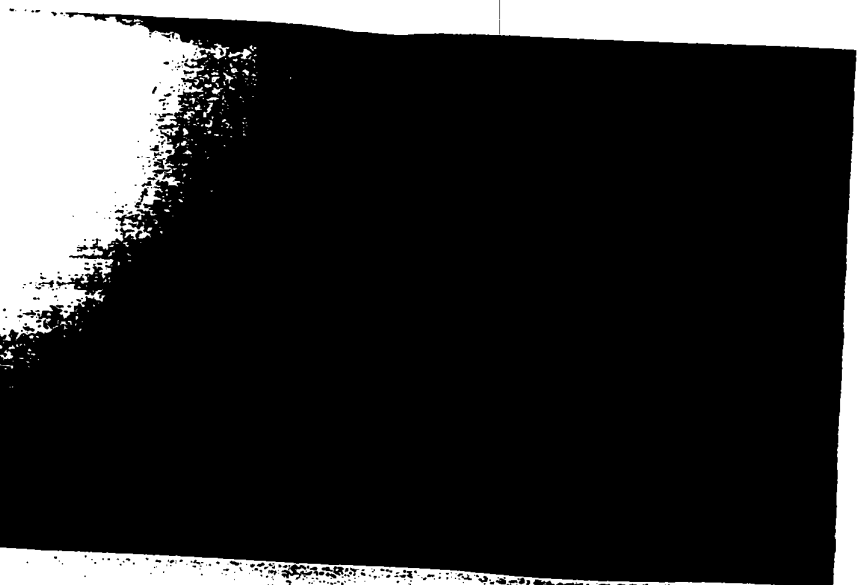

24 MAY 1984

May 16th 1984.

REF. UFO/Further Investigation.

Dear Sir,

E25 P.F.

Regarding your last letter dated 24th April 1984. What we here at the Center for UFO Studies would like to know is:-

- ① Could we have the total numbers of UFO sightings for the years 1978-1979-1980-81-82-83-84?
- ② We also believe and have been told that the MOD released CASE files to fellow British UFO researchers (IAN MRZYGLOD) is one who received one. So why do other investigators in the phenomena, not get any DATA even when required?. SUCH AS OUR INVESTIGATION TEAM.
- ③ RENDLESHAM FOREST CASE (MOD) Could we have the case and what conclusion you reached?.
- ④ HAVE ALL UFO SIGHTINGS for the years 1982-1983 been identified by MOD or outside sources?..

We hope you will be able to help with our questions as it is of utmost importance that we get our facts right, so there is no misunderstanding between us all, Cooperation is the ESSENCE.

Thank you very much for your help, and may we send our best wishes for the future.

Yours Sincerely



MINISTRY OF DEFENCE
Main Building Whitehall London SW1A 2HB

Telephone 01-218 (Direct Dialling)
01-218 9000 (Switchboard)

File. (6)

[Redacted]

Your reference

Our reference
D/DS8/10/209-648

Date

25 May 1984

[Redacted]

Thank you for your two letters, of 7 and 8 May.

In your letters you asked whether we had any information concerning three reported sightings of flying objects which the observer could not identify. The only one of these for which I could find a report was the one on 27 December 1980, at RAF Woodbridge. I am therefore attaching a copy of a report by Colonel Charles Hal of the United States Air Force, which is the only information we have on this.

You may also be interested in the two attached Parliamentary Questions.

Yours sincerely,
A. Matthews

MINISTRY OF INTERNATIONAL COMMUNICATIONS
14 MAY 1984
FILE

Mr Mathewson,
Defence Secretariat 8,
Room 7230,
Ministry of Defence,
Main Building,
Whitehall,
London SW1A 2HB.



DATE: 8.5.84.

Dear Sir/Madam,

Could you please forward any information that you have on the following reports of Unidentified Flying Objects.

Date and time of sighting: Friday the 11th of July 1980, 3.30 am.

Description of object: A large flattened oval shaped object, Colour yellow then blue/white then changed back to yellow.

Position of observers: Soyland Moor between Littleborough and Todmorden North Yorkshire, England.

How Observed: Naked eye only.

Direction object first seen: North.

Weather conditions: Cold and clear with Moon and stars visible.

Names of observers: Police Constable Stephen Howarth and Police Constable Christopher Fernhead.

Second report.

Date: December the 27th 1980 at 3am.

Description of object: Metallic triangular object, 2/3 meters across its base and 2 meters high. One red light on top with a row of blue lights underneath. The object was on some sort of "legs".

Position of observers: Tangham wood, near USAF base at RAF Woodbridge, Suffolk England.

How observed: Naked eye and 8-12 power lense.

Direction object seen: North.

P.T.O.



degrees above the horizon, just above tree top level
and on the ground.

Distance: Not determined.

Movements: Object came down through trees in a multitude of colours and
landed on the ground. When moving off it manoeuvred between trees.

Weather conditions: Not determined.

Names of observers: Lt Colonel Charles I Helt, deputy commander of the
USAF 31st Tactical Flying Wing. Plus both British
and American Air Force personnel.

I would appreciate all the information that your department has on the
two UFO reports that I have mentioned.

If there is any cost involved for the above reports I will be only too
pleased to oblige.

Hopefully I will receive your reply before too long, until then I am,
Yours Sincerely,

[Redacted signature block]

MINISTRY OF DEFENCE Room 7230
Main Building Whitehall London SW1A 2HB
Telephone 01-218 (Direct Dialling)
01-218 9000 (Switchboard)

File (680)

[Redacted]

Your reference

Our reference
D/DS8/10/209-639

Date

22 May 1984

[Redacted]

I am afraid that previous references to us having released sixteen reports of flying objects which the observer could not identify from the South Wales area appear to have been mistaken. In fact we released only fifteen such reports. I enclose, though, the one report I think you are missing to complete the "set".

You also asked about Lt Col Halt's report on the lights which were seen near RAF Woodbridge on 27 December 1980. Mr Stanley's answer in Hansard of 24 October 1983, of which you have a copy, made it clear that we received a copy of this report and satisfied ourselves that it contained nothing of defence interest. I have nothing to add to that.

Yours sincerely

L. Hatterton

5th MAY

Dear Mr. Mathewson

I thank you very much for your letter of 4th May and the Ufo reports. I requested 16 reports which you did mention in the letter, but on inspection I counted only 14, would it be possible to be also sent these remaining two to complete the set following the last one: (A 191765 83 5 MINUTES OVER SWANSEA AIRPORT?) You informed me that my request as a "serious inquirer" does not come into the category you were thinking of on a "specific sighting." Therefore enclosed

3

with this letter is a document
which may UFO clubs know about.
could you tell me the following:

1. is the document a true statement
of happenings 27, 28 29, Oct 1980.
2. did the ministry investigate the
claim of a supposed UFO landing at
a USA base woodbridge, suffolk if so,
what were their findings. I look
forward too possibly receiving the
two ministry reports. please excuse
my persistence.

Yours sincerely

DEPARTMENT OF THE AIR FORCE

11A.83
RAF JWA
4

13th Jan 81

CO

Unexplained Lights

RAF/CC

1. Early in the morning of 27 Dec 80 (approximately 0300L), two USAF security police patrolmen saw unusual lights outside the back gate at RAF Woodbridge. Thinking an aircraft might have crashed or been forced down, they called for permission and allowed three patrolmen to proceed on foot. The on-duty flight chief responded and allowed three patrolmen to proceed on foot. The object was described as being metallic in appearance and triangular in shape, approximately two to three meters across the base and approximately two meters high. It illuminated the entire forest with a white light. The object itself had a pulsing red light on top and a bank(s) of blue lights underneath. The object was hovering or on legs. As the patrolmen approached the object, it maneuvered through the trees and disappeared. At this time the animals on a nearby farm went into a frenzy. The object was briefly sighted approximately an hour later near the back gate.
2. The next day, three depressions 1 1/2" deep and 7" in diameter were found where the object had been sighted on the ground. The following night (29 Dec 80) the area was checked for radiation. Beta/gamma readings of 0.1 milliroentgens were recorded with peak readings in the three depressions and near the center of the triangle formed by the depressions. A nearby tree had moderate (.06-.07) readings on the side of the tree toward the depressions.
3. Later in the night a red sun-like light was seen through the trees. It moved about and pulsed. At one point it appeared to throw off glowing particles and then broke into five separate white objects and then disappeared. Immediately thereafter, three star-like objects were noticed in the sky, two objects to the north and one to the south, all of which were about 10° off the horizon. The objects moved rapidly in sharp angular movements and displayed red, green and blue lights. The objects to the north appeared to be elliptical through an 8-12 power lens. They then turned to full circles. The object to the south remained in the sky for an hour or more. The object to the south was visible for two or three hours and beamed down a stream of light from time to time. Numerous individuals, including the undersigned, witnessed the activities in paragraphs 2 and 3.

CHARLES I. HALT, Lt Col, USAF
Deputy Base Commander

Your ref: D/DS8/10/209.

A. Mathewson,
Defence Secretariat 8, Room 7230,
Ministry of Defence,
Main Building,
Whitehall,
LONDON, SW1A 2HB.

May 19th., 1984.

Dear Sir/Madam,

Thank you for your letter of the 10th instant, which was very informative.

With reference to the 'Hansard' extract for 13th. March last, my colleagues and I were wondering whether you could kindly provide OSEAP with a breakdown of the sources for the UFO reports your Department received from 1981 to 1983. It seems quite remarkable that you have received so many, whilst OSEAP, and others, have received none.

In fact, OSEAP has received no reports for approximately 18 months! Hence our interest in some old, interesting cases.

So, if at all possible, we would like to know from what channels the MOD gets its reports in such great numbers.

Coming to Rendlesham, would you confirm that an unidentified aerial craft hovering very near to a Tactical Combat Base must surely have defence implications? The facts, as reported by Col. Halt would seem to give some cause for concern. One does not feel reassured by the nature of the Secretary of States for Defence's reply in Hansard for 24th. October last.

Once again, thank you for your cooperation in these matter.

Yours truly,





ence Secretariat 8, Room 7230
MINISTRY OF DEFENCE
 Main Building Whitehall London SW1A 2HB
 Telephone 01-218 2638 (Direct Dialling)
 01-218 9000 (Switchboard)

File. (E)

[Redacted]

Your reference

Our reference
 D/DS8/10/209-611
 Date

10 May 1984

[Redacted]

Thank you for your recent letters on the subject of reported UFO sightings. I am sorry to have been some time replying.

To take your general question first, it has now been decided not to publish the reports of alleged UFO sightings we receive. As you may know, we get several hundred of these each year and to prepare them for publication would be a considerable editorial task, for which we have neither the staff nor resources. This would also fall well outside our defence responsibilities. However, for some time we have been prepared to release the details of particular reports to serious enquirers provided the information was easily identifiable and readily to hand. That continues to be our policy.

As to your questions about specific 'incidents', I am afraid that neither the first, third nor fourth of those you mentioned was reported to the Ministry of Defence, so I am unable to help with those. The only information we have on the lights seen in Redlesham Forest is the report by Colonel Halt of the United States Air Force. You will probably already have seen this, but in case you have not I enclose a copy.

You may also be interested in the enclosed Parliamentary Questions on the Ministry of Defence's interest in alleged UFO sightings.

Yours Sincerely,

J. Matteson

91

30th. April, 1984

Defence Secretariat Division 8,
Ministry of Defence,
Main Building,
Whitehall,
LONDON, SW1A 2HB.

Dear Sir/Madam,

re: release of information on UFO Reports.

Regarding the above matter, until early this year I had received courteous replies to my enquiries, from your Department.

However, my colleagues and myself are somewhat perturbed that you have apparently ceased to respond to any letters from this quarter. Indeed, this year I have written on behalf of OSEAP on three occasions: 22nd. January, 13th. March and 23rd. March.

Following reports in the press, however accurate, we were led to believe that you were supplying information where possible in response to enquiries from serious bodies. OSEAP is one such organisation and feels that the least you could do is to write and confirm your Department's position on the matter being discussed. Surely it would be just a matter of good manners, even though you will have more important matters to attend to.

Yours faithfully,

587

22nd. January, 1984

Defence Secretariat Division B,
Ministry of Defence,
Main Building,
Whitehall,
LONDON, SW1A 2HB.

MINISTRY OF DEFENCE
U.S. 8
30 JAN 1984
FILE

Dear Sir/Madam,

Re: release of information relating to UFO reports.

Just a line to say my colleagues and I are still interested in your Department's position on the above matter.

Therefore, may we again ask you what is being done with the information, if anything?

Yours truly,



93

(68)

23rd. March, 1984

Defence Secretariat Division 8,
Ministry of Defence,
Main Building,
Whitehall,
LONDON, SW1A 2HB.

RECEIVED
4 APR 1984
FILE

Dear Sir/Madam,

re: release of information on UFO reports.

Following my letter to your department of the 13th. inst., I would like your comments on a front page article that appeared in 'THE ADVERTISER' for March 16th. It concerns the release of 16 reports to BUFCRA and contains the following: "So it is interesting now to see that a Government department is now willing 'to consider providing reports on specific incidents to serious inquiries', writes Walter Harding".

On behalf of my colleagues I would ask your criteria for serious inquiries and their acceptance.

If the newspaper report is correct then I take this opportunity to ask your department on the following cases:-

1. Llanerchymedd, Anglesey 1st. Sept., 1978. (OSMAP was involved in the main investigation of the incidents and subsequently produced a special report).
2. Rendlehsam Forest. (Highly publicised in the press but seemingly lacking substance. Although not initially involved, OSMAP has become interested in the case after paying this area a visit last year).
3. Llandrillo, Glynedd 23rd. Jan., 1974. (OSMAP followed this incident up last year which involved aerial lights and earth tremors. Although these may not be connected).
4. South Stacks, Holyhead, Anglesey: 4th. Feb. 1974. (Due to nearness, in time, to the previous incident OSMAP has become interested in the washing-up on the shore of a plane-like object. The RAF and Aberporth Range Establishment said it was not theirs and the Navy's underwater research base at Portsmouth was sent a drawing. The object was 9' long, with a wingspan of 5', with a black aluminium body and the remnants of an aerial.)

I trust that you will kindly supply any information you are able on the above incidents. I hardly need remind you that OSMAP is a serious investigative team.

Finally, I would ask your department if you have had any connections with a mysterious UFO group called: APEN, or a David McGroarty who resides in Redcar and is supposedly a representative of the same.

Yours truly,

[Redacted signature]

[Redacted signature]

Your ref:- D/DS8/10/209.

Defence Secretariat Division 8,
Ministry of Defence,
Main Building,
Whitehall,
LONDON, SW1A 2HB.

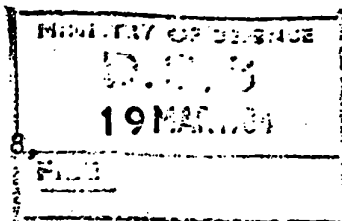

13th. March, 1984.

Dear Sir/Madam,

Further to my letter of 22nd. January last and the report in the 5th. March issue of the Daily Express, I once again would ask your department's position in relation to the release of information relating to UFO reports.

I would again stress the need for caution in releasing this type of material. Not only because of 'national security' considerations, but also of the type of person who might have access to it. You will be aware that 'distortion of the facts' is endemic within so-called UFO research circles.

Hoping that this communication is received favourably, I am

Yours faithfully,





MINISTRY OF DEFENCE, Room 7230
 Main Building Whitehall London SW1A 2HB
 Telephone 01-218 (Direct Dialling)
 01-218 3000 (Switchboard)

[Redacted]

Your reference

Our reference
 D/DS8/10/209-5,7

Date

21 April 1984

[Redacted]

Thank you for your letter of 9 March 1984. Your suggestion that the Ministry of Defence has documents relating to the alleged UFO sighting at RAF Woodbridge in December 1980, other than Colonel Halt's report, is quite mistaken.

Perhaps I ought to explain that the sole interest of the Ministry of Defence in reported sightings of Unidentified Flying Objects (UFOs) is to establish whether they have any bearing on the defence of the country.

There is no organisation in the Ministry of Defence appointed solely for the purpose of studying UFOs, and no staff are employed on the subject full time. The reports we receive are referred to the staff in the Department who are responsible for the air defence of the United Kingdom, and they examine the reports as part of their normal duties.

Since our interest in UFOs is limited to possible defence implications we have not carried out a study into the scientific significance of these phenomena. Unless there are defence implications we do not attempt to identify sightings and we cannot inform observers of the probable identity of the object seen. The Department could not justify the expenditure of public funds on investigations which go beyond the pure defence interests.

We have to recognise that there are many strange things to be seen in the sky, but we believe there are adequate explanations for them. They may be satellite debris re-entering the earth atmosphere, ball lightning, unusual cloud formations, meteorological balloons, aircraft lights, aircraft at unusual angles or many other things. There is certainly no evidence that alien spacecraft have landed on the planet. Although we have not carried out our own studies, we are aware of independent studies into the UFOs, notably by the University of Colorado published in 1969. This concluded that 90% of all UFOs reported could be plausibly related to ordinary phenomena.

I attach copies of 2 recent Parliamentary Questions on the Ministry of Defence's interest in UFO reports. I am returning your stamped addressed envelope.X

Yours sincerely,

Gene Materson

ICS:

[REDACTED]

Defence Secretariat Division 8.

MINISTRY OF DEFENCE
Main Building Whitehall
London
SW1A 2HB.

9th March 1984.

RE:- WOODBRIDGE INCIDENT DEC '80'

Dear Sir/Madam,

I have been informed that a certain amount of UFO Documents are being released. As I am a credited UFO Investigator for BUFORA, 'BRITISH UFO RESEARCH ASSOCIATION'. I would be grateful if you could assist me with my enquiries. For the past 3 years I have been one of the main investigators on the Woodbridge incident in December 1980. We the investigators, the other being [REDACTED], now know that Photographs, Tape recording and signed witnesses statements Do exist. Our source of information being reliable. We have been informed that the Ministry of Defence has Documentation on the said mention case. We received Col Charles I Holt's report via the Freedom of Informations Act, in the United States. This report was first sent to the MoD, by Sqn Leader Donald Moreland. the MoD eventually sent a copy to the US Air Force in the United States. We have been informed that Col Halts report is but only a brief account of the incident and a full report has been made. We would be grateful if you would provide us with the later also other Documentation on the Woodbridge incident. I have enclosed just one of many Documents we have received. The enclosed being from the Air Force Headquarters 513th Combat Support Group (U.S.A.F.E.).

We look Forward to your Acknowledgement of this Letter.

YOURS SINCERELY

[REDACTED]



DEPARTMENT OF THE AIR FORCE
HEADQUARTERS 513TH COMBAT SUPPORT GROUP (USAF)
APO NEW YORK 09127

[REDACTED]

[REDACTED]

14 June 1983

I am pleased to be able to respond to your request for information dated 7 May 1983. As you may now know, the 513th Combat Support Group provides document management services for Headquarters, Third Air Force. After extensive effort, we are able to successfully answer your four separately directed requests for information concerning unexplained lights on 27 December 1980.

It might interest you to know that the US Air Force had no longer retained a copy of the 13 January 1981 letter written by Lt Col Charles I. Halt. The Air Force file copy had been properly disposed of in accordance with Air Force Regulations. Fortunately, through diligent inquiry and the gracious consent of Her Majesty's government, the British Ministry of Defence and the Royal Air Force, the US Air Force was provided a copy for you. We trust this adequately explains the initial inability to provide a favorable response.

As you also asked, we have attached such documentation as we had concerning the processing of your several FOIA requests as of receipt of your 7 May 1983 request.

Sincerely,

PETER W. BENT, Colonel, USAF
Commander

DOCUMENT # 4



Main Building Whitehall London SW1A 2HB
Telephone 01-218 (Direct Dialling)
01-218 9000 (Switchboard)

Your reference

Our reference
D/DS8/10/209-525

Date

14 April 1984

Thank you for your letter of 31 January. I am sorry to have taken so long before replying.

I should first of all point out that the sole interest of the Ministry of Defence in reported sightings of UFOs is to establish whether they have any bearing on the defence of the country.

There is no organization in the Ministry of Defence appointed solely for the purpose of studying UFOs, and no staff are employed on the subject full time. The reports we receive are referred to the staff in the Department who are responsible for the air defence of the United Kingdom, and they examine the reports as part of their normal duties.

Since our interest in UFOs is limited to possible defence implications we have not carried out a study into the scientific significance of these phenomena. Unless there are defence implications we do not attempt to identify sightings and we cannot inform observers of the probable identify of the object seen. The Department could not justify the expenditure of public funds in investigations which go beyond the pure defence interests.

We have to recognize that there are many strange things to be seen in the sky, but we believe there are adequate explanations for them. They may be satellite debris re-entering the earth atmosphere, ball lightning, unusual cloud formations, meteorological balloons, aircraft lights, aircraft at unusual angles or many other things. There is certainly no evidence that alien spacecraft have landed on the planet. Although we have not carried out our own studies, we are aware of independent studies into the UFOs, notably by the University of Colorado published in 1969. This concluded that 90% of all UFOs reported could be plausibly related to ordinary phenomena.

I attach copies of two recent Parliamentary Questions on the Ministry of Defence's interest in UFO reports.

Yours sincerely

L. Hattersan

99

DATE. JANUARY 31st 1984

To/MOD, DEPT, S4 (AIR) main Building

REF.. UFO Investigations.

Dear Sir/madam,

With reference to UFO Investigations which your department have been dealing with from 1980 up to present time 1984. So could you kindly supply us with our following requests for information.

1. UFO Cases for Wigan 1980 - onwards.
2. Official Evaluation of the Bentwaters, Suffolk sighting 27/12/1980.
3. The overall opinion of your depts, Investigations (do UFOs exist?) (Not flying saucers with green men inside.)
4. CONDON Committee report (USA) could you supply us with it / or where would we be able to obtain it from.
5. Any International Contact addresses you could supply us with.

Many thanks for your co-operation, time and trouble.

Yours sincerely

[Redacted signature]

[Redacted name]



MINISTRY OF DEFENCE ROOM 7230
Main Building Whitehall London SW1A 2HB
Telephone 01-218-2638 (Direct Dialling)
01-218 9000 (Switchboard)

Your reference

Our reference

D/DS8/10/209-518

Date

24 April 1984

[REDACTED]

[REDACTED]

Thank you for your letter of 12 March. Since Mrs Titchmarsh, my predecessor here, last wrote to you it has been decided not to publish the reports of alleged UFO sightings we receive. As you may know, we receive hundreds of these reports each year and to prepare them for publication would involve a great deal of editorial work, for which we have neither the money nor the staff. This would, in any case, fall outside our defence responsibilities. It is also not possible for you to be allowed privileged access to these reports. Although they contain no classified papers they are, like all Ministry of Defence files, subject to the Public Records Act. Under this Act official files are, in general, to remain closed for 30 years after the last action has been taken on them.

You may be interested in the two attached Parliamentary Questions on the MOD's interest in reports of alleged UFO sightings.

Yours sincerely,

David Mather

101

11

12 MAR 1984

Dear Sirs,

We have corresponded on many occasions in the past regarding your low-key investigation into UFO sightings. I am fully conversant with your policy and appreciate the difficulties under which you labour.

You will realise, if you check back through my records, that I have no grand illusions about UFOs. I do not believe you are covering up evidence of an alien invasion. Essentially, I believe that 90% (plus) of sightings are readily explicable. As for the rest, the solutions lie in terms of novel atmospheric and psychological phenomena. Some of these phenomena have decided scientific value, and since they represent the harnessing of radiating energy have (both in my view and that of a number of scientists who work with me) potential to offer economic advantages to those who study them.

For this reason I have been urging the department since 1978 to release the files you hold to the scientific community, since the problem (as you freely admit) is one much more of a scientific nature than of a defence concern.

In October 1982 you wrote to me advising that a decision had been taken to release data and you were currently contemplating the best way by which this might be achieved. I kept this to myself at the time, since I did not wish to prejudice your decision with receipt of numerous claims. However, you gave me a statement to make public some months later and several sample reports from South Wales. These were in lieu of the case I specifically requested.

Recently, I was approached by the Sunday Observer, who planned to do an article on the MOD and UFOs. I gave them full cooperation, to the maximum of my ability, since I felt this was the right kind of influential source to discuss the matter publicly. I had no control over Martin Bailey's conclusions (which I think were reasonably fair), but it is difficult to do this when I have incomplete data. Had I been in possession of more documents I could have possibly helped the paper give an even more fair appraisal.

In February 1983 myself and Peter Warrington published an article "The Neglected Science of UFOs" in New Scientist. You may peruse this, since it adequately reflects my position on the matter. I think this demonstrates that I am not making outlandish claims, and that cooperation between us could be to mutual advantage. You must realise the problems caused when unscrupulous sources wrongly promoted the essence of the Woodbridge Air Base (December 1980) sighting, in the News of the World last year. This generated public relations headaches I am sure. And the real truth was in no sense given. After a lot of work on the case I know that a UFO and aliens were not responsible for the events of that night.

Following our New Scientist article, Peter and I were approached by a scientific publishers (Blackwell) and commissioned to write a book that reflects the history of science and its dealings with the UFO phenomenon. A section of this deals with official government policy towards UFO science (in the USA and here). In this way a few thousand words on the British MOD policy have been included.

I have brought this to your attention before, in a letter that did not receive a reply. We feel that this book will be influential, reaching as it does the scientific community (ie it will not be a mass market paperback). It would be an ideal opportunity to help one another. That is, you offering data to us, and we offering a good public relations job for you. This we would be delighted to do. Whilst the book is largely complete we can delay a little while, if there is promise of significant new data.

When I first discussed the document release with your department, almost 18 months ago, I requested privileged access to the files. I suggested that I would be happy to sign the official secrets act, or any other waiver you may require to protect the identity of the people who have written to you, which you explained to me as the main problem in clearing the data for release. Surely such a commitment on my part would be sufficient?

I supported my application with reference to Bill Chalker, who acts as my opposite number in Australia (we are coordinators of national investigations). Prior to the granting of the Freedom of Information Act in Australia he was offered access (on terms similar to those I suggest) to all the cleared documents. He was then encouraged to report on this as widely as possible in the UFO media. This he did, very fairly I might add. His reports (which I have if you wish to see them) have had a number of significant advantages.

- (1) They have effectively demolished the 'cover-up' myth, by showing in detail the full truth of the file content.
- (2) They have eased the burden of enquiries that the government would have received by presenting this material, through Bill, to the people who required it.
- (3) They allowed a person with the UFO background knowledge (that your team do not have) to act in a public relations capacity for the government. In other words all enquiries are deflected to him, and he is in a position to respond to them.

This is an effective system that has worked well. Of course, I realise it was precipitated by the imminence of Freedom of Information there. No doubt the Australian government wished to avoid what took place in the USA, where law suit after law suit (using the F.O.I. act) has been taboed in order to obtain perceived documents.

I asked Bill to endorse my claim for similar treatment, which he did.

One problem you raised was that there are many UFO groups here, and that sponsorship of me might leave you open to requests from the others. But surely you are able to make a value judgement and appreciate that most groups lack knowledge, experience, and a credible public relations position. I have been a full-time worker in this field for six years and have established a public relations position. I also have hopefully demonstrated that I am capable of expressing the situation objectively, without wild suppositions or illogical assumptions.

I am in the position to report to the UFO community, as Bill Chalker did. In this way I could help you. What is more, via the book, Peter and I could truly provide a beneficial service to both science and yourselves.

You did say that if a substantial delay, further to the one already in effect in late 1982, were to take place, then you would seriously consider this proposal. As it would now appear that you have concluded (I think reasonably) that there is

3..

just too much information to release it all, then this might make the suggestion even more advantageous.

Can I please ask you to contemplate such a move. It is in my interests to present the realities of the UFO problem to the scientific community, and to try to educate the UFO enthusiasts (based upon the facts). It is in your interests to ease the public relations burden, whilst being as open as possible. It will not be easy to demonstrate that you are not withholding vital information. To do so effectively we must start now. There may not be a Freedom of Information Act here at the present, but as you must know it is feasible. If it comes, it would be well to have prepared, just as they did in Australia. In which case I believe that my proposition must have merit.

Yours sincerely,



NOTE

1988/10/209

84

AD MOD Sy 1

CORRESPONDENCE FROM [REDACTED]

1. I attach a letter and attachments we recently received from a [REDACTED] for your information and whatever action you think necessary.
2. As you will see, [REDACTED] has sent us a copy of a letter which purports to be a report of landing of a UFO crewed by several "entities" near RAF Bentwaters in 1980. This letter is clearly a forgery. Although it is written on MOD headed paper it is most certainly not an official document. I do not want to be too alarmist about what could be simply a harmless joke, but this could prove rather embarrassing if it ever found its way to a newspaper. The News of the World ran a very sensational story in October last year, alleging that a UFO had landed near RAF Bentwaters. They based this on a report by a USAF Colonel, of some unexplained lights near the base, which they had managed to get hold of. They would no doubt seize on this letter as further "proof" that something had happened. There could also be Parliamentary interest. Sir Patrick Wall MP has recently asked 2 questions on the MOD's interest in UFO reports and might ask questions about this. In the worst case, then, this letter could cause a good deal of unnecessary and unwelcome bother.
3. [REDACTED] addressed the letter to Mrs Titchmarsh, my predecessor in this post, because he had spoken to her shortly after the News of the World story appeared: my phone number has become fairly well known amongst UFO spotters. The reference to DS8 in the text of the letter is also easily explained; anyone who has received a letter explaining our policy on UFO reports would know that DS8 are the responsible division, although we do not, contrary to what the letter suggests, carry out investigations.
4. By way of background, I attach a note explaining the limited extent of our interest in UFO reports and the 2 recent PQS. I should, of course, be happy to speak to you about this.

A. Mathewson

A MATHEWSON
DS8
MB 7230 2638 MB

105

DS17

RECORDED DELIVERY

30th March, 1984

For the attention of Miss P. Titchmarsh

Ministry of Defence,
Main Building,
Whitehall,
LONDON SW1A 2HB

Dear Miss Titchmarsh,

re: UFO Matters and Rendlesham Forest Sighting.

I enclose a copy of a letter which I received in January, together with a copy of the front of the envelope which contained the same, and would be grateful to receive your comments thereon.

Thanking you in anticipation.

Yours faithfully,

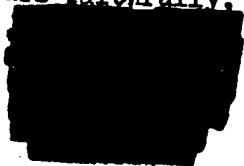



MINISTRY OF DEFENCE

Main Building, Whitehall, London SW1A 2HB

Telephone (Direct Dialling) 01-218 [REDACTED]

(Switchboard) 01-218 9000

Dear [REDACTED],

As you know, OSI has completed a report on the landing of a craft of unknown origin crewed by several entities near RAF Bentwaters on the night of December 29/30 1980.

Interestingly, OSI reports that the entities were approximately 1½ metres tall, wore what appeared to be nylon-coated pressure suits, but no helmets. Conditions on the night were misty, giving the appearance that the entities were hovering above ground level.

Tape recordings were made on which the entities are heard to speak in an electronically synthesized version of English, with a strong American accent. Similar transmissions intercepted irregularly by NSA since 1975. (See attached - Flag A)

According to OSI, entities had claw-like hands with three digits and an opposable thumb.

Despite original reports (Flags B - G), OSI said the craft was not damaged but landed deliberately as part of a series of visits to SAC bases in USA and Europe. Reports that craft was repaired by US servicemen or was taken on to the base are not confirmed by OSI.

Landing is not considered a defence issue in view of the overt peaceful nature of the contact, but investigations by DS8 are to be continued on [REDACTED] authority. Precautionary plan for counter-information at a local level involving [REDACTED] and a [REDACTED] [REDACTED], is strongly recommended.

Sincerely

[REDACTED]

The sole interest of the Ministry of Defence in reported sightings of Unidentified Flying Objects (UFOs) is to establish whether they have any bearing on the defence of the country.

There is no organization in the Ministry of Defence appointed solely for the purpose of studying UFOs, and no staff are employed on the subject full time. The reports we receive, which we are grateful for, are referred to the staff in the Department who are responsible for the air defence of the United Kingdom, and they examine the reports as part of their normal duties.

Since our interest in UFOs is limited to possible defence implications we have not carried out a study into the scientific significance of these phenomena. Unless there are defence implications we do not attempt to identify sightings and we cannot inform observers of the probable identity of the object seen. The Department could not justify the expenditure of public funds on investigations which go beyond the pure defence interests.

We have to recognize that there are many strange things to be seen in the sky, but we believe there are adequate explanations for them. They may be satellite debris re-entering the earth atmosphere, ball lightning, unusual cloud formations, meteorological balloons, aircraft lights, aircraft at unusual angles or many other things. There is certainly no evidence that alien spacecraft have landed on the planet. Although we have not carried out our own studies, we are aware of independent studies into the UFOs, notably by the University of Colorado published in 1969. This concluded that 90% of all UFOs reported could be plausibly related to ordinary phenomena.

Hansard Extract

13 March 1984

Cols 132 & 133

Unidentified Flying Objects

Sir Patrick Wall asked the Secretary of State for Defence (1) how many alleged landings by unidentified flying objects have been made in 1980, 1981, 1982 and 1983, respectively; and how many have been investigated by his Department's personnel;

(2) how many unexplained sightings there have been in 1980, 1981, 1982 and 1983, respectively; and which of these had been traced by radar and with what result.

Mr. Lee [*pursuant to his reply, 9 March 1984, c. 728*]: For the years in question, the Ministry of Defence received the following numbers of reports of sightings of flying objects which the observer could not identify: 350, 600, 250, and 390. Reports of alleged landings are not separately identified. The Department was satisfied that none of these reports was of any defence significance and, in such cases, does not maintain records of the extent of its investigations.

24 OCTOBER 1983

Col. 62

RAF Woodbridge (Alleged Incident)

Sir Patrick Wall asked the Secretary of State for Defence (1) if he has seen the United States Air Force memo dated 13 January 1981 concerning unexplained lights near RAF Woodbridge;

(2) whether, in view of the fact that the United States Air Force memo of 13 January 1981 on the incident at RAF Woodbridge has been released under the Freedom of Information Act, he will now release reports and documents concerning similar unexplained incidents in the United Kingdom;

(3) how many unexplained sightings or radar intercepts have taken place since 1980.

Mr. Stanley: I have seen the memorandum of 13 January 1981 to which my hon. Friend refers. Since 1980 the Department has received 1,400 reports of sightings of flying objects which the observers have been unable to identify. There were no corresponding unexplained radar contacts. Subject to normal security constraints, I am ready to give information about any such reported sightings that are found to be a matter of concern from a defence standpoint, but there have been none to date.

110



RAF LIAISON OFFICE

Royal Air Force Bentwaters Woodbridge Suffolk IP12 2RQ

Telephone Woodbridge 3737 ext ~~2332~~ 2557

G12
71

0/209

Mrs P J Titchmarsh
Defence Secretariat Div 8a
Ministry of Defence
Main Building
Whitehall
LONDON
SW1A 2HB

Your reference

Our reference

BENT/6/AIR

Date

30 March 1984

Dear Mrs Titchmarsh

Further to your letter D/DS8/10/209 dated 17 November 1983, enclosed is the pre-advertising for a book on the "Rendlesham UFO". Most of the advertising is erroneous but it will no doubt stir up another hornet's nest!

D E G CRAWFORD
Squadron Leader
RAF Commander

Copy to: HQ 3AF/SRAFLO

///

This book will explain the meaning of that significant statement.

Furthermore, the authors have been given dramatic information and documentation by the British Defence Ministry, who for the first time have come clean about their involvement in the UFO subject.

This could be the book which finally ends the cover up.

In view of the sensational, but absolutely verifiable and documented, evidence presented, there can be no way **Sky Crash** can fail to attract excitement, controversy and huge sales.

The British edition will be published in the summer of 1984, and the ripples following publication will spread across the world.

ORDER FORM

Send no money now, but return this today to:

Neville Spearman Limited,
The Priory Gate,
Friars Street,
Sudbury, Suffolk.

We will advise and bill you when copies of **Sky Crash** are available.

..... cut here

I would like to receive my copy/ies of **Sky Crash**. Please advise me immediately when I will send you my remittance.

My Name is.....

My Address is.....

.....

.....

Date.....

The World's First
officially confirmed
Close Encounter

SKY CRASH

A
Cosmic
Cover-Up

Brenda Butler, Dot Street & Jenny Randle
(Author of **Alien Contact**, etc.)

'Are UFOs physical craft flown by beings of superior intelligence? Do the governments of the world know this fact, absolutely and certainly? Have their representatives met with and talked with these aliens elsewhere? And is this incredible truth slowly, but finally, about to be told?

These are strong words, and they are meant to be. For this book promises to be perhaps the most important ever written about the UFO phenomenon.

But the implications of this TRUE account go far beyond our personal beliefs or disbeliefs. This investigation poses questions of the greatest importance to the future of the world.

The case begins with an unidentified blip on a radar screen at a joint civil and military air base near Rendlesham Forest in Suffolk in the last few days of 1980. This recording is taken by US Air Force Intelligence Officers who tell (in confidence) a fantastic story. From this comes trickles of independent confirmatory information out of a strategic base which lies in the fore of Europe's defence. Gradually this trickle grows to a torrent, and the various accounts come together. It is clear that an event, unsurpassed in the history of the UFO phenomenon, has occurred on British soil under the eyes of numerous military personnel from the US Air Force, including some of very high rank.

As the investigation continued to bring new witnesses and information to light, a point was reached where the number of individuals (both civilian and military) described two major close encounters within three days. The evidence was overwhelming. This has become one of the best documented UFO incidents of all time. And it involves two protracted encounters with an incredible, and undeniably physical, craft which had come down into the woods not, it would seem, for the first time!

Its pilots, however, were not of this world. They were aliens.

One, at least, of the military encounters offers irrefutable evidence of a landing lasting three hours, during which the entities held a long conversation with a high-ranking officer. Their craft had been damaged and was placed under military guard while the aliens made hasty repairs enabling them to take

off again. In their wake they left strong pieces of evidence, including symmetrical trace marks, radiation, damage to surrounding trees, and several pieces of visual and auditory documentation which were immediately placed under strict secrecy. The traces themselves were subsequently destroyed by the authorities in a calculated manner.

All of these events took place within half a mile of the perimeter fence of a front-line NATO air base. This joint US Air Force and RAF operation is always on alert and is staffed by anti-tank bombers. It is shielded by one of the tightest radar networks in the world.

Of course, this story alone would be of the highest significance. But it represents just one major facet of this historic book. For the events have received official confirmation from the governments of both Britain and the USA. Documentation to prove this will be shown. The extent of this confirmation surprised even the investigative team. For the first time ever, a terrifying UFO close encounter is officially confirmed by the Ministry of Defence and the Pentagon.

Having established beyond all reasonable doubt the reality of the events, the book moves on to examine its implications. Various alarming scenarios will be presented and these will span across witchcraft, drugs, space warfare and a near nuclear holocaust! But it would seem that the facts make the real truth abundantly clear. And that truth may be more horrific than any of these alternatives.

All documentation and discussion will be supported by a full analysis of official papers on UFOs which have been forced out of the US Government by recent legal action. The hundreds of reports, transcripts and research memoranda have been reappraised in the light of the incidents at Rendlesham Forest. And suddenly they make sense.

The continued and long-standing involvement of the CIA, the FBI and many other security agencies makes it certain that, as one of these agency documents actually says: 'The problem transcends the level of individual departmental responsibilities and is of such importance as to merit cognisance and action by the National Security Council.'

From: I G McEwen Defence Secretariat 8

File 61

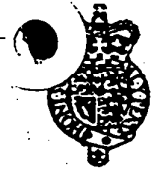

MINISTRY OF DEFENCE
Main Building Whitehall London SW1A 2HB
Telephone 01-218 6248 (Direct Dialling)
01-218 9000 (Switchboard)

Air Commodore M J Royson MVO RAF
Air Attache
British Embassy
Bonn
BFPO 19

Your reference

Our reference

D/DS8/10/209 340

Date

21 March 1984

Dear Air Commodore Royson,

REQUEST FOR UFO INFORMATION

1. Thank you for your letter of 2 March. I do apologise for not having replied to your earlier letter which enclosed a request from the editor of the CEWAP Journal for information on last October's "News of the World" report about alleged unidentified sightings outside RAF Woodbridge.
2. The report mentioned in the newspaper article was, indeed, sent to MOD but I am afraid that much of the story printed by the "News of the World" was, to say the least, exaggerated. There was no question of any contact with "alien beings", no unexplained radar contacts and no evidence that anything had landed in the forest.
3. It may help if I explain the very limited interest which MOD has in so-called UFO reports. Our sole concern is to establish whether they reveal anything of defence interest (intruding aircraft, for example) and we do not pursue our investigations beyond the stage at which we are satisfied that there are no defence implications. As far as the Woodbridge incident is concerned, the Department satisfied itself at the time that there was no reason to consider that the alleged sightings had any defence significance.
4. MOD has never denied that strange things may be seen in the sky, but we believe that there are perfectly normal explanations for these, such as falling satellite debris, unusual cloud formations or aircraft lights. If Herr Warner followed articles printed elsewhere in the British press after last Autumn's report in the "News of the World" he will have seen a number of attempts to explain the alleged sightings in more down to earth terms. As I recall, one favourite possibility was that the light seen came from the Orfordness lighthouse.
5. I am sorry that I cannot be more helpful. I am afraid that there are no official photographs of RAF Bentwaters and RAF Woodbridge of the type sought by Herr Warner.

Inver Matteson
for Ian McEwen (AOE)



MINISTRY OF DEFENCE

Main Building, Whitehall, London SW1A 2HB

Telephone (Direct Dialling) 01-218 6592

(Switchboard) 01-218 9000

- 1. All
- 2. ~~1/2/84~~
- 3. File

D/DS 8/10/209 ✓



20 March 1984

Dear Ralph,

I do apologise for not replying earlier to your correspondence about the alleged unexplained sightings at RAF Woodbridge in 1980. As Andrew Mathewson may have explained when you spoke to him, we have had staff changes in the relevant section of DS 8 and have been under a lot of pressure generally. However, that does not excuse the delay for which I hope you will accept my sincere regrets.

I am afraid, however, that there is very little information I can give you in answer to your questions about RAF Woodbridge. I am not sure whether DS 8 had responsibility for the MOD interest in UFO matters in your day but, if it did, you will remember how very limited MOD's interest is in such reports. Our sole concern is to establish whether they reveal anything of defence interest (intruding aircraft, for example) and we do not pursue our investigations beyond the stage at which we are satisfied that there are no direct defence implications.

As far as the Woodbridge incident is concerned, John Stanley, Minister for the Armed Forces confirmed in answer to a written Parliamentary Question from Sir Patrick Wall MP on 24 October last year, that MOD had, indeed, received the USAF report to which you refer. The Department satisfied itself at the time that there was no reason to consider that the alleged sightings had any defence significance.

That is not to say, however, that Colonel Halt and the other personnel mentioned in the report were ~~as you suggest~~ suffering from hallucinations. Speaking personally, I can accept that people do from time to time see things in the sky which they find difficult to explain. I am sure you ~~will~~ ^{with hardship} agree that in many cases normal explanations come to light, such as falling meteorites or satellite debris, unusual cloud

u

formations or aircraft lights. The press has carried
~~articles on the Woodbridge incident last Autumn you will have~~
~~seen the results of a good deal of investigative journalism~~
~~which turned up rational and down-to-earth explanations for~~
~~what was seen. As I recall, the light from the Orfordness~~
~~lighthouse was one favourite possibility. What the true~~
~~explanation is, I do not know; as I said earlier, MOD does~~
~~not attempt to investigate reports to the point at which a~~
~~positive identification can be made. I can assure you,~~
~~however, that there is no evidence of anything having intruded~~
~~into British airspace and 'landing' near RAF Woodbridge.~~

Kind regards

Yours sincerely

Brian Webster

17th January, 1984

B.M. Webster, Esq.,
Head of DS8,
Ministry of Defence,
Main Building,
Whitehall SW1

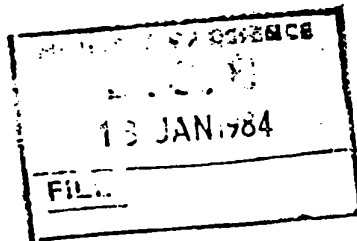

Dear Webster,

I wrote to you on 7th November last year about an incident alleged to have occurred at RAF Woodbridge in December 1980. I sent you a reminder on 2nd December. I have not received a reply or an acknowledgement to either of these letters although nearly two and a half months have elapsed since I first wrote.

I trust it has not become the policy of the Ministry of Defence to reply only to questions pressed by an MP.

The matters raised in my letters seem to me of public importance. I am not alone in thinking so. I hope I shall now shortly receive your comments.

In case my previous letters have been subject to some mishap in the post I am sending this to you by recorded delivery.

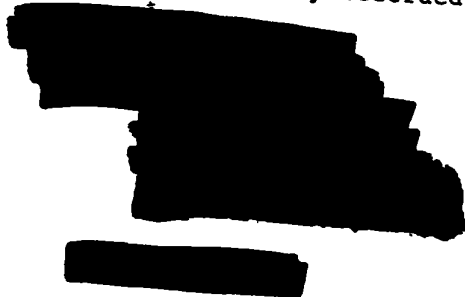

Defence Secretariat Division 8a

MINISTRY OF DEFENCE
Main Building Whitehall London SW1A 2HB

Telephone 01-218 (Direct Dialling)
01-218 9000 (Switchboard)

File

(E113)

Your reference

Our reference
D/DS8/10/209-1986

Date

7 December 1983

Thank you for your letter of 14 November.

I have made further enquiries about the date of the alleged sightings at RAF Woodbridge in 1980 but as the incident is now almost three years old we can only rely on the dates given in Lt Col Halt's letter dated 13 January 1981. We have no knowledge of any local constabulary involvement.

I can confirm no investigations were carried out by the Ministry of Defence until Lt Col Halt's report was received and there is no truth in the story that radar records have been confiscated. In fact, no unidentified object was seen on radar during the period in question.

As regards the star-like objects referred to in Lt Col Halt's report, I have already explained that once the Ministry of Defence was satisfied that there was nothing of defence interest in the sightings no further investigations were conducted.

I hope this will help to clarify the points you raised.

Per

P J TITCHMARSH (MRS)

118

(67)

2nd December, 1983

B.M. Webster, Esq.,
Head of DS8,
Ministry of Defence,
Main Building,
Whitehall, SW1

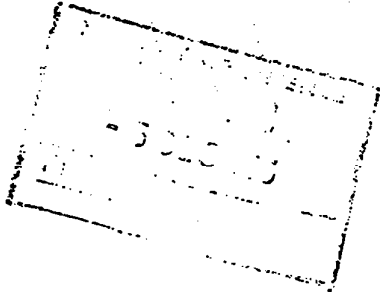

Dear Webster.

I wonder whether you can yet let me have a reply to my letter to you of 7th November about an alleged incident at RAF Woodbridge in December 1980 ?

Since I wrote to you I have been shown a copy of a letter issued by the US Department of the Air Force in June this year. I attach a photocopy. This indicates that the Ministry of Defence have for some time been aware of the report made by Lt.Col. Halt, of which I sent you a copy with my previous letter.

If I may again say so, Lt.Col. Halt's report really does seem to require some comment by the Ministry of Defence, considering the Defence importance of RAF Woodbridge and its USAF element.

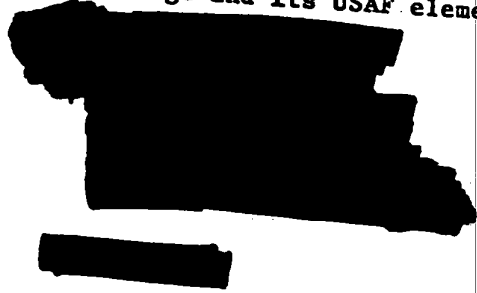

Attachment: Photocopy of US Dept. of the Air Force letter of 14 June 1983

119



DEPARTMENT OF THE AIR FORCE
HEADQUARTERS SIXTH COMBAT SUPPORT GROUP (USAFS)
APO NEW YORK 09127

[REDACTED]

14 June 1983

I am pleased to be able to respond to your request for information dated 7 May 1983. As you may now know, the 513th Combat Support Group provides document management services for Headquarters, Third Air Force. After extensive effort, we are able to successfully answer your four separately directed request for information concerning unexplained lights on 27 December 1980.

It might interest you to know that the US Air Force had no longer retained a copy of the 13 January 1981 letter written by Lt Col Charles I. Halt. The Air Force file copy had been properly disposed of in accordance with Air Force Regulations. Fortunately, through diligent inquiry and the gracious consent of Her Majesty's government, the British Ministry of Defence and the Royal Air Force, the US Air Force was provided a copy for you. We trust this adequately explains the initial inability to provide a favorable response.

As you also asked, we have attached such documentation as we had concerning the processing of your several FOIA requests as of receipt of your 7 May 1983 request.

Sincerely,

PETER W. BENT, Colonel, USAF

[* The document referred to is not attached. A copy was enclosed with [REDACTED] letter to Mr. Webster d/d 7 November 1983]



RAF LIAISON OFFICE
 Royal Air Force Bentwaters Woodbridge Suffolk IP122RQ
 Telephone Woodbridge 3737 ext 2238 2557

Mrs P J Titchmarsh
 Defence Secretariat Div 8a
 Ministry of Defence
 Main Building
 Whitehall
 London
 SW1A 2HB

Your reference
 Our reference
 BENT/19/76/Air
 Date
 30 November 1983

Dear Pamela

01209.

The enclosed letter was sent to the Base Commander here, and I forward it for any action you consider necessary.

They didn't teach me about the Sub-Dwarfs Solar System when I studied Astro Navigation at Navigation School!

D H Moreland

D H MORELAND
 Sqn Ldr
 RAF Cdr

Encl.

I hope you will forgive a letter from a complete stranger but
wish to express to you a very serious matter.

210012

Around your Base and several more in Suffolk and Norfolk
you have seven different peoples from outer space planets watching
every move that is made by your forces. These seven peoples from
these planets are very kind and advanced cultures and would and
would like to meet you all from each Airforce base to speak to
you about many dangers that face our whole planet. I know three
of these creatures, or peoples very well. Two of them come from
the main Sequence - Sub-Dwarfs Solar System, a neighbouring Solar
System in the vicinity of our own Sun. One of these peoples are
named the Krxyzcs from the second planet out from the Star Kruger 60B
and the next is the Cock-Et--Tarros the third planet out from
the star Barnards and one is from our own Solar System Pluto;
The Plutonions I know well.

Now within the next 3 months perhaps possibly before that
they will give you a kind of a demonstration to prove to you all
that they are serious with regard to meeting some of your High
Ranking Officers. The way they will prove to us is by speaking
through your sophisticated Radio Systems and at times abducting High
Ranking Men from your Bases, and they will be doing the same
in other countries including Russia.

Sir, I beg of you not to make fun of this letter as
it is the truth as Heaven is my Judge and this matter I can
help you with.

10/209/1

THE BASE COMMANDER
U.S. AIR FORCE
R.A.F. WOODBRIDGE
SUFFOLK



POSTCODE



THE BASE COMMANDER
U.S. AIR FORCE

R.A.F. WOODBRIDGE
SUFFOLK

123

Squadron Leader D H Moreland RAF



RAF LIAISON OFFICE

Royal Air Force Bentwaters Woodbridge Suffolk IP12 2RQ

Telephone Woodbridge 3737 ext 2557

E1047

Mrs P J Titchmarsh
Defence Secretariat Division 8a
Ministry of Defence
Main Building
Whitehall
London SW1A 2HB

Your reference

Our reference
BENT/19/76/Air

Date

25 November 1983

Dear Pam,

RECEIVED
- 1 10/209
- 1 10/209

Thankyou for your letter and enclosure concerning the unexplained lights seen at Woodbridge during December 1980. The incident is now almost 3 years old and no one here remembers it clearly. All we have is Lt Col Halts' letter dated 13 January 1981.

A study of this letter shows that the first sighting was at 0300 hrs on 27 Dec 80 and that the second sighting was on the night of 29 Dec 80.

I have no knowledge of any local constabulary involvement.

Yours sincerely

D H Moreland

7

124



SECRETARIAT DIVISION
MINISTRY OF DEFENCE
 Main Building Whitehall London SW1A 2HB
 Telephone 01-218 2638 (Direct Dialling)
 01-218 9000 (Switchboard)

[Handwritten initials]

Sqn Ldr D H Moreland RAF
 RAF Liaison Office
 RAF Bentwaters
 Woodbridge
 Suffolk IP12 2RQ

Your reference

Our reference

D/DS8/10/209-1873
 Date

17 November 1983

Dear Squadron Leader

I attach a copy of a letter received from a member of the public following publication of the News of the World reports on the Woodbridge "UFO" sightings.

[Redacted] has written twice before on this subject and now alleges that the date given in Lt. Col. Malt's report of the initial sighting as being on 27 December 1980 is inaccurate. I would be grateful for your comments on this.

I would also be grateful if you could discover whether the second sighting mentioned in the report took place on the same night or a subsequent night, and if so, the date of the second sighting.

Yours sincerely

Pam Fitzmarsh

P J FITZMARSH (Mrs)

E 100/3

Your ref #/DS8/10/209

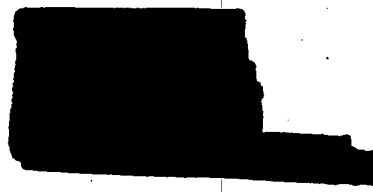

P J Titchmarsh
MoD
Main Building
Whitehall
SW1A 2HB

10/27/83
10/209

1983 November 14

Dear Mrs Titchmarsh,

In response to yours of Nov 10, I have confirmed with Suffolk Constabulary that they were called to the scene of the Woodbridge UFO at 4.11 am on December 26, 1980. They said that all they could see was the lighthouse. They were called out again at 10.30 am on Dec 26 to examine the reported landing marks. There seems little doubt that the date of Dec 27 given in Col Halt's letter (of which I have a copy) is wrong. This also casts doubt on the second date he gives for the later events. If your investigators were looking into events on Dec 29 and 30, as I understand was the case, they were almost certainly concentrating on the wrong day(s). Perhaps the whole case needs re-investigation.

I had hoped not to trouble you again on this subject, but there are a couple of points that perhaps you could clarify for me. Firstly, it is being said that an investigation including confiscation of radar records began before the Halt memo was even written. Do you know this to be true? Secondly, I should be interested to know what your own investigators thought was the probable cause of the "star-like objects" that Col Halt reported in the final para of his letter.

Yours sincerely,





MINISTRY OF DEFENCE
 Main Building Whitehall London SW1A 2HB
 Telephone 01-218 (Direct Dialling)
 01-218 9000 (Switchboard)

File
 (98)



Your reference

Our reference
 D/DS8/10/209-1843

Date

10 November 1983



Thank you for your letter of 26 October and your notes on the Woodbridge UFO case.

My only comment on your explanation of the incident is the date on which the sighting took place. I can only confirm that the date given on the report sent to us by Lt Col Halt was 27 December as stated in the News of the World article. There is, however, little substance in much of that article; there is no confirmation that a UFO landed, there was no question of contact with "alien beings" and no unidentified object was seen on radar.

The report was handled in the Ministry of Defence in accordance with normal procedures ie it was passed to staff concerned with air defence matters who examine such reports to satisfy themselves that there are no defence implications. In this instance MOD was satisfied that there was nothing of defence interest in the alleged sightings.

As regards the question of releasing files, I explained in my letter of 19 October that Ministry of Defence files are subject to the Provisions of the Public Record Acts and are not therefore released to the public until 30 years have elapsed after the last action taken on them. I am aware of any precedent set in the past with regard to the release of UFO files in this country. I am sorry, therefore, that we cannot accede to your request.

Yours sincerely,
 P.J. Titchmarsh
 P J TITCHMARSH (Mrs)

127

7th November, 1983

B.M. Webster, Esq.,
Head of DS8,
Ministry of Defence,
Main Building,
Whitehall, SW1

Dear Webster,

You'll find if you check your records that I occupied that 'hot seat' of yours in DS8 from 1969 to 1972 (subsequently retiring as AUS(L) in 1977). So I'm not writing to you in any frivolous expectation that you'll have much time to spare for what may well strike you as a relatively unimportant enquiry - I well remember the rate at which more urgent stuff crosses that desk of yours! But if you can help, I'd be grateful.

I'm currently in touch with Lord Hill-Norton (former CDS) and Patrick Wall MP about that odd report of some alleged 'UFO' nonsense at RAF Woodbridge and thereabouts in late December 1980. You may have seen the (characteristically) sensational cover which THE NEWS OF THE WORLD gave to this elderly event in their issues of 2nd and 9th October this year. (And for all I know, you were the luckless chap who drafted the written Answer which was given to Patrick Wall on 24th October - if it wasn't DS4 ??).

I merely come into the picture because I'm currently writing a book (pretty cool and sceptical) about the UFO 'thing': it's certainly a phenomenon, at least to the extent that the public continue to work themselves up about it from time to time; my own treatment of it is that it's a pretty example of modern myth in the making (among some other current myths); and I think I've hooked a publisher for this modest essay.

But Peter Hill-Norton has rather set me back on my haunches by taking the Woodbridge 'event' with a degree of seriousness, and I've since seen the full text of the report made by Lt.Col. Halt, Deputy USAF Base Commander, on 13 January 1981. This was released in America earlier this year under the Freedom of Information Act by the Department of the Airforce. The releasing letter astounded me (and Peter Hill-Norton et al.) by saying: "The Air Force file copy had been ... disposed of... Fortunately, through ... the gracious consent of ... the British Ministry of Defence ... the US Air Force was provided with a copy ..."

I wonder if you'd be kind enough (within security limits) to let me know what you can in answer to the following questions.

- a. Did the MOD indeed get a copy of Lt.Col. Halt's report of 13 January 1981?
- b. If so, did it correspond with the attached photocopy which has been released in the US? (Sorry for atrocious copy!).
- c. The report implies either that Halt (et al.) was the subject of hallucinations or that something not explained in the report intruded

into British airspace and 'landed' in British territory on 27 and 29 December 1980. Which of these alternatives does the MOD embrace ?

- d. Neither alternative is particularly comforting. None of us would wish our respected colleagues in the USAF (with control of vital weapons) to be deceived by illusory phenomena; equally, none of us would welcome evidence that British airspace and territory can be intruded upon with impunity. Whichever of the two views the MOD adheres to, what steps have been taken since Lt.Col. Halt's report was received ?

My apologies again for troubling you with these questions. My immediate interest is the one I've mentioned: I'm writing a book. But it seems to me that broader questions are involved. Somebody or other may well decide to press them further in the public arena. I hope (and, as a former Head of DS8, I believe !) that ~~that~~ reasonable answers can be given.

[REDACTED]

[REDACTED]

[REDACTED]

Enclosure: Photocopy of report dated 13 January 1981

REF ID: A11111

CU

13 Jan 81

Subject: Unexplained Lights

RAF/CC

1. Early in the morning of 27 Dec 80 (approximately 0300L), two USAF security police patrolmen saw unusual lights outside the back gate at RAF Woodbridge. Thinking an aircraft might have crashed or been forced down, they called for permission to go outside the gate to investigate. The on-duty flight chief responded and allowed three patrolmen to proceed on foot. The individuals reported seeing a strange glowing object in the forest. The object was described as being metallic in appearance and triangular in shape, approximately two to three meters across the base and approximately two meters high. It illuminated the entire forest with a white light. The object itself had a pulsing red light on top and a bank(s) of blue lights underneath. The object was hovering or on legs. As the patrolmen approached the object, it maneuvered through the trees and disappeared. At this time the animals on a nearby farm went into a frenzy. The object was briefly sighted approximately an hour later near the back gate.

2. The next day, three depressions 1 1/2" deep and 7" in diameter were found where the object had been sighted on the ground. The following night (29 Dec 80) the area was checked for radiation. Beta/gamma readings of 0.1 milliroentgens were recorded with peak readings in the three depressions and near the center of the triangle formed by the depressions. A nearby tree had moderate (.05-.07) readings on the side of the tree toward the depressions.

3. Later in the night a red sun-like light was seen through the trees. It moved about and pulsed. At one point it appeared to throw off glowing particles and then broke into five separate white objects and then disappeared. Immediately thereafter, three star-like objects were noticed in the sky, two objects to the north and one to the south, all of which were about 100' off the horizon. The objects moved rapidly in sharp angular movements and displayed red, green and blue lights. The objects to the north appeared to be elliptical through an 8-12 power lens. They then turned to full circles. The object to the south was visible for two or three hours and beamed down a stream of light from time to time. Numerous individuals, including the undersigned, witnessed the activities in paragraphs 2 and 3.

CHARLES I. HALT, Lt Col, USAF
Deputy Base Commander

Document #5



Am

EQ
+3

MINISTRY OF DEFENCE WHITEHALL LONDON SW1A 2HB

TELEPHONE 01-218 9000
DIRECT DIALLING 01-218 6169

D/S of S/210/83

November 1983

MINISTRY OF DEFENCE
D.S.8
- 1 NOV 1983
FILE 16/209

Mr. Kelly

Internals:

~~Head of DS8~~
D of Ops (A Def) (RAF)

Thank you for your letter of 19th October enclosing the one attached from your constituent, [REDACTED]

I can assure you that there is not a grain of truth in the allegation that there has been a "cover up" about alleged UFO sightings.

As you will recall from your time as Minister for the Royal Air Force, reports of alleged sightings are examined by operations staff to see whether there is any interest from a defence point of view. No such interest was found in the case of the incident reported in the "News of the World" of 2nd October, or in any of the other sightings reported in the UK. In the "News of the World" incident there was in fact no question of any contact with "alien beings", nor was any unidentified object seen on radar.

My Department's interest remains solely in the implications for the air defence of the UK, as you may have seen in John Stanley's answer in the House on 24th October (copy attached) to a question about the "News of the World" report.

Michael Heseltine
Michael Heseltine

The Rt Hon Merlyn Rees MP

131

E96

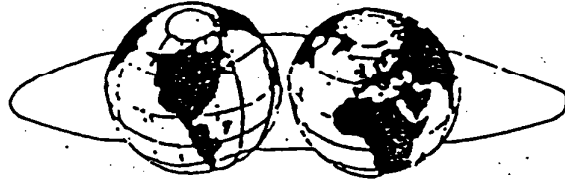

Mr Merlyn Rees M.P.
/o House of Commons,
Westminster,
London.
6/10/83.

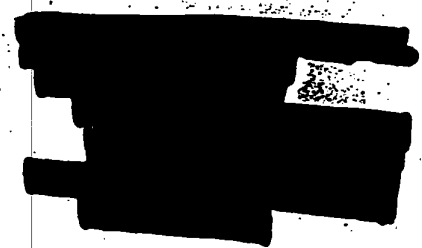

Dear sir,

As an investigator for the Yorkshire UFO Society I have been investigating the UFO phenomenon for the past two years in and around the Batley-Morley area.

I have recently read with great interest the articles which appeared in the News of the World on October 2nd and October 9th regarding a UFO which landed in Suffolk and was "covered up" by the Ministry of defence.

These two articles only confirm what has been widely believed for some time, and that is that the M.O.D are involved in a tremendous "cover up" on all UFO phenomenon in the British Isles.

It is on this matter of a "cover up" that I urge you to raise the question of why the M.O.D are "covering up" information pertaining to UFOs, in the House of Commons at the first opportunity on my behalf.

As a public organisation the Yorkshire UFO Society believes that the general public have the right to know the truth about UFOs, and I feel it is about time the M.O.D came clean and stopped this silly charade when saying they have no official interest in UFOs, but they still continue to hide the truth from the public.

Only when more voices are aired against the M.O.D cover up, then and only then will they release all the information they have been suppressing for years.

Hopefully you will be able to help me with my request for the release of information and I hope to hear from you soon.

Yours Sincerely

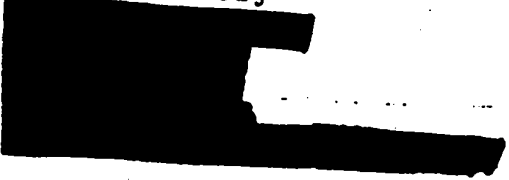

24 OCTOBER 1983

Col. 62

EG

95

RAF Woodbridge (Alleged Incident)

Sir Patrick Wall asked the Secretary of State for Defence (1) if he has seen the United States Air Force memo dated 13 January 1981 concerning unexplained lights near RAF Woodbridge;

(2) whether, in view of the fact that the United States Air Force memo of 13 January 1981 on the incident at RAF Woodbridge has been released under the Freedom of Information Act, he will now release reports and documents concerning similar unexplained incidents in the United Kingdom;

(3) how many unexplained sightings or radar intercepts have taken place since 1980.

Mr. Stanley: I have seen the memorandum of 13 January 1981 to which my hon. Friend refers. Since 1980 the Department has received 1,400 reports of sightings of flying objects which the observers have been unable to identify. There were no corresponding unexplained radar contacts. Subject to normal security constraints, I am ready to give information about any such reported sightings that are found to be a matter of concern from a defence standpoint, but there have been none to date.

MINISTRY OF DEFENCE
D.S. 8
31 OCT 1983
FILE 10/209

(291)

Mrs P J Titchmarsh
MoD
Whitehall SW1A 2HB

1983 October 26

Dear Mrs Titchmarsh,

Thank you for your letter of October 19. In response I enclose a paper summarizing my own investigations into the Woodbridge UFO case. You will see that I have painted a rather different picture from that in the News of the World. If anyone has any comments on this paper, I should be pleased to hear them.

I appreciate that it is not normal practice to release MoD files, but I understand that the precedent has been set with regard to one or two files of UFO cases. In view of the continuing public interest in the Woodbridge case, plus the need to prevent an awful lot of wasted time if there really is a straightforward solution, I would hope that an exception can be made. I for one would accept a censored account of the conclusions. If your office does reconsider lifting the veil of secrecy over this case, I do hope you will let me know immediately.

Yours sincerely,



1983 October 18

Tel: 01 - 568 6100

AN EXPLANATION OF THE WOODBRIDGE UFO - A SUMMARY

On October 2, 1983, the News of the World reported the alleged landing of a UFO outside RAF Woodbridge in Suffolk at Christmas 1980. Prime documentary evidence of the event consists of a letter from the deputy base commander, Charles I. Halt, which was published by the News of the World. The News of the World also interviewed an eye witness, a former security guard given the pseudonym of Art Wallace.

In outline, the story is that two patrolmen reported seeing unusual lights in the sky at 3 a.m. Subsequently they reported seeing a strange object among the trees of a nearby forest that pulsed and "illuminated the forest with a white light". Next day, three depressions in the ground were found. Later that night, the colonel himself was witness to a "sun-like light seen through the trees" and three star-like objects in the sky.

The facts of the matter are these:

1. The date of December 27 given in the NoW is evidently wrong. Police records reveal that they were called to the scene at 4.11 a.m. on December 26. They have no record of any further calls on December 27 or thereafter.
2. Records of the British Astronomical Association's meteor section show that at 2.50 a.m. on the morning of December 26, 1980, a brilliant fireball (a piece of natural debris from space) burned up in the atmosphere over southern England. Witnesses reported it as being comparable in brightness to the Moon, which was then three-quarters full. Anyone seeing this spectacular event could easily conclude that an object was crashing to the ground.
3. Shortly after publication of the NoW story, local forester Vincent Thurkettle realized that a line drawn from the back gate of RAF Woodbridge through the alleged UFO landing site points directly towards the lighthouse at Orford Ness. On the night of October 6-7 1983 Ian Ridpath visited the site with Mr Thurkettle and confirmed that the pulsating lighthouse beam does indeed appear to hover among the trees near ground level and lights up the forest with a white light. Although the lighthouse is 5 miles away, it is so brilliant that it appears much closer. An observer moving through the forest could easily conclude that the pulsating lighthouse was also moving. If a UFO had been present as well as the lighthouse, the witnesses should have seen not one but two pulsating lights in their line of sight.

continued -

The flashes from the lighthouse were videotaped by a BBC camera crew for an item transmitted on Breakfast Time TV. In an interview in The Times on October 3, Mr Thurkettle noted that the site was covered with 75-ft-high pine trees 10 ft apart at the time of the alleged landing. He attributed the indentations in the ground to rabbits.

4. When local police arrived at the scene on the night of the alleged landing they found nothing untoward. According to the police account, the only lights they could see were those of the Orford lighthouse. Next day they examined the indentations in the forest and concluded that they were probably made by an animal. Air Traffic Control received reports of "aerial phenomena" over southern England that night. By coincidence, in addition to the 3 a.m. fireball, the Russian Cosmos 749 rocket had re-entered the atmosphere over southern England at 21.07 on the night of December 25, and was widely seen.

5. Although it is not clear from the NoW account, it seems that the last paragraph of Col. Halt's letter refers to events on the following night. He says: "A red sun-like light was seen through the trees. It moved about and pulsed." Either this is the lighthouse again, or we are asked to believe that a second UFO landing occurred on the same site. Col. Halt's "star-like objects...10 degrees off the horizon" were probably just that - stars. The reported "angular movements" are attributable to movements in the observer's eye (the autokinetic effect, familiar when watching a stationary star) and the "green and blue lights" are an effect caused by simple twinkling when a star is low in the sky. The object to the south that remained visible for 2 to 3 hours and which "beamed down a stream of light from time to time" is almost certainly Sirius, the brightest star in the sky. red, /

Conclusion: Observers who interpreted the 2.50 a.m. fireball as a craft descending into the forest outside RAF Woodbridge might subsequently regard the unexpected appearance of the lighthouse as the same object that had landed. Once they were convinced that something strange was happening, the witnesses could then easily misinterpret other natural phenomena as UFOs. Such behaviour is common in UFO cases. In short, the details of this case for which a reliable account exists are subject to straightforward, rational explanation.

NB: These notes are for private circulation only and are not for publication or quotation without the express permission of the author.

 1983 October 18

HANSARD EXTRACT

24 OCTOBER 1983

Col. 62

10259
E89
+2

RAF Woodbridge (Alleged Incident)

Sir Patrick Wall asked the Secretary of State for Defence (1) if he has seen the United States Air Force memo dated 13 January 1981 concerning unexplained lights near RAF Woodbridge;

(2) whether, in view of the fact that the United States Air Force memo of 13 January 1981 on the incident at RAF Woodbridge has been released under the Freedom of Information Act, he will now release reports and documents concerning similar unexplained incidents in the United Kingdom;

(3) how many unexplained sightings or radar intercepts have taken place since 1980.

Mr. Stanley: I have seen the memorandum of 13 January 1981 to which my hon. Friend refers. Since 1980 the Department has received 1,400 reports of sightings of flying objects which the observers have been unable to identify. There were no corresponding unexplained radar contacts. Subject to normal security constraints, I am ready to give information about any such reported sightings that are found to be a matter of concern from a defence standpoint, but there have been none to date.

M1

KT (288)
+1

Priorities

This non-oral question has been allocated to Minister(AF) for answer.

2. Would you please supply a draft reply and background note, together with any relevant Hansard extracts and Press cuttings, to reach this office at the time shown on the front cover.
3. Please submit a copy of the draft answer to PS/USofS(AF) when returning this, allowing sufficient time for USofS(AF) to comment.

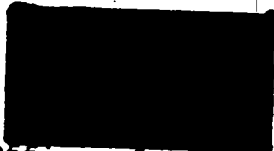

Office of Minister(AF)
Room 6386 Main Building
Extension [redacted]

21-10-83

M2

APS/Minister(AF) (thro' DUS(Air))

Copy to:
APS/US of S(AF)
Ops(GE)2(RAF)

1. I have placed opposite a draft reply to PQ 7607C.
2. The same background note has been provided for PQ 7608C and PQ 7609C.



21 October 1983

[redacted] DS 8
MB 7257 [redacted]

138

PQ 7067C

(E87)

SIR PATRICK WALL (CONSERVATIVE) (BEVERLEY)

Sir Patrick Wall

- To ask the Secretary of State for Defence, if he has seen the United States Air Force memo dated 13 January 1981 concerning unexplained lights near RAF Woodbridge.

SUGGESTED ANSWER (Mr Stanley)

Yes.

Background Note

(86)

These three questions follow from the News of the World article of 2 October 1983 (Annex A) describing an alleged UFO sighting by USAF personnel at RAF Woodbridge in Suffolk on 27 December 1980.

The report of 13 January 1981 (Annex B) examined by the Air Staff and DS 8. It was concluded that there was nothing of defence interest in the alleged sighting.

There was, of course, no question of any contact with "alien beings" nor was any unidentified object seen on any radar recordings, as alleged in the News of the World.

A BBC investigation into the incident following publication of the News of the World Article concluded that a possible explanation for the lights seen by the USAF personnel was the pulsating light of the Orfordness lighthouse some 6 - 7 miles away.

The sole interest of the MOD in UFO reports is to establish whether they reveal anything of defence interest (eg intruding aircraft). MOD investigations are not pursued beyond the point at which we are satisfied that a report has no defence implications. No attempts are made to identify and catalogue the likely explanation for individual reports.

Last year, Lord Long, during a debate initiated by the Earl Clancarty, said that he would look into the possibility of publishing such reports as are received by the Ministry of

Defence. US of S(AF) has now decided to release compilations of reports. They will be published on a quarterly basis and will be available to members of the public, at a small charge to cover costs. US of S(AF) had planned to make an announcement shortly in the House of Lords through an arranged PQ. Pending arrangements for an announcement in the Lords, US of S(AF) has agreed that we should indicate the decision in the Commons.

141

UFO Sighting Reports: Security

The Earl of Cork and Orrery: My Lords, I beg leave to ask the Question which stands in my name on the Order Paper.

The Question was as follows:

To ask Her Majesty's Government how many of the 2,250 sightings of UFOs reported to the Ministry of Defence in the years 1978-81 were, and still are, classified for reasons of security.

Viscount Long: None, my Lords.

The Earl of Cork and Orrery: My Lords, I thank my noble kinsman for that Answer. May I ask him two questions? First, what did he mean when he said in his Answer on, I think, 4th March that reports of sightings that were considered to be of interest to defence were in fact classified? Secondly, what procedures may be open to individuals or organisations who would like to see the reports?

Viscount Long: My Lords, with regard to the latter part of my noble friend's supplementary question, there is no reason why he should not come and see the reports. Not many of them come in because not many people actually report sightings. There is no cover up in that respect. As for the first part of my noble friend's supplementary question, I stick to what I said earlier.

The Earl of Kimberley: My Lords, can my noble friend say why, when I previously asked a supplementary question, he said that the figures had got lost in the way to the Ministry, whereas today he says that they are there and available for anyone to see? Can he therefore place them in the Library for all of us to see?

Viscount Long: My Lords, I will look into that and find out whether it is possible for your Lordships to see them. I should like all of your Lordships to see them in the Library, if possible.

Lord Strabolgi: My Lords, may I ask the Government whether they think that any of these UFOs are manned spacecraft coming from a planet outside the solar system, as is believed by the "ufologists"?

Viscount Long: My Lords, the noble Lord can believe that; anything is possible.

Lord Shinwell: My Lords, do I understand that the noble Viscount the Minister in his reply to the original question does not deny that UFOs exist? Is it possible to use the word "possible" very carefully, but

liberately- that all the information is well-known to the Ministry of Defence, but that for diplomatic and other reasons it is not prepared to make an announcement?

Viscount Long: No, my Lords, it is not prepared to make an announcement because it has not got the facts to make an announcement with authority behind it.

Lord Beswick: My Lords, the Question asks about 2,250 sightings. The noble Viscount says that there are very few sightings reported to the Ministry of Defence. Does that mean to say that the figure in the Question is incorrect?

Viscount Long: No, my Lords, it was on the original assumption that there are probably many sightings that are not reported to the Ministry of Defence. That is what I was really referring to. Therefore, at this stage what we have said is that we have got.

Lord Beswick: My Lords, I should like to clear up that point. The Question refers to 2,250 sightings "reported" to the Ministry of Defence. The Question I was asked was, "Is that figure correct, or not?"

Viscount Long: That is correct, my Lords, up to this moment.

Lord Wade: My Lords, may I ask which Ministry is responsible for UFOs?

Viscount Long: None, my Lords. Reports come into the Ministry of Defence, and anyone can take them from there.

Viscount St. Davids: My Lords, has anybody yet found an empty beer can marked, "Made in Centaurus", or any similar object? Until they have, will the Ministry deal with these matters with very considerable scepticism, please?

Viscount Long: My Lords, I am not the Minister for conservation, if it is a question of beer cans.

Lord Morris: My Lords, if something is said to be unidentified, how can it possibly be said to exist?

Viscount Long: A very good question, my Lords.

Lord Leatherland: My Lords, can the Minister tell us whether any of the unidentified flying objects are Ministers who are fleeing from the Cabinet just now?

Viscount Long: No, my Lords.

The Earl of Clancarty: My Lords, may I ask the noble Viscount whether he is aware of a Ministry of Defence document concerning UFOs, which was published in the July 1978 issue of a journal called *Viewpoint Aquarius*? Furthermore, he is aware that under the heading of "Contacts" there were listed 18 names, and alongside each name there was given the town which was the location of the supposed occurrence? There were also given classifications and a date and time relating to each name. Is the noble Viscount aware that there was a tremendous distribution of the document to other Government departments, and to NORAD and the CIA? I should like to ask whether in this case the word "contacts" means close encounters?

Viscount Long: Yes, my Lords, I have the document here, and it has nothing to do with the Ministry of Defence. It is made up to look rather like a Christmas menu. Its existence in the Ministry of Defence has been denied on television. Someone else has made it up. It is not a Ministry of Defence document—not the way it is made up, like a Christmas menu.

THURSDAY OF LOTUS
Thursday, 4th March, 1982.

The House met at three of the clock (*Prayers having been read earlier at the Judicial Sitting by the Lord Bishop of Derby*): The LORD CHANCELLOR on the Woolsack.

British Citizens: Overseas Supplements

Lord Hatch of Lusby: My Lords, I beg leave to ask the first Question which stands in my name on the Order Paper.

The Question was as follows:

To ask Her Majesty's Government how many British citizens received British Expatriates Supplementation Scheme or Overseas Service Aid Scheme supplements in 1979 and in 1981 and what further changes are planned.

The Parliamentary Under-Secretary of State, Foreign and Commonwealth Office (Lord Trefgarne): My Lords, the average number of British citizens receiving British Expatriates Supplementation Scheme or Overseas Service Aid Scheme supplements in 1979 was 4,083. In 1981, the comparable figure was 2,975. The numbers have fallen steadily since 1970 and reductions are expected to continue at about 10 per cent. per annum over the next few years. No changes in terms of service are planned at the moment.

Lord Hatch of Lusby: My Lords, may I ask the noble Lord the Minister whether he has read the Answer given by his colleague to a similar Question which I put in December? The Answer, which I paraphrase, was that the numbers had fallen because local indigenous people had now become sufficiently trained to take those positions. If the noble Lord has looked since at these figures, would he agree that this is not an adequate answer and that this is a deliberate policy by the Government to reduce the number of British citizens who are given supplements to work overseas? Would the noble Lord further agree that this is causing very great difficulty to universities, to technical colleges and to a whole range of national activities in the Commonwealth?

Lord Trefgarne: No, I do not agree with that, my Lords. I have indeed studied the Answer which my noble friend Lord Skelmersdale gave to the noble Lord, Lord Hatch of Lusby, at the end of last year. The reasons which my noble friend then gave remain correct.

Lord Hatch of Lusby: But surely the figures which have been given this afternoon, if I heard correctly, have reduced the number by about 25 per cent. in two years. Does this not entail a great reduction in British influence all over the Commonwealth? And is the noble Lord aware that particularly in universities it is causing very great anxiety and difficulty over the recruitment of the requisite trained staff?

HL 15 M2

Lord Trefgarne: My Lords, the numbers have indeed declined, as I described in the original Answer and as was referred to at the time of the earlier Question at the end of last year. But one has to remember that these schemes are operated in the closest consultation with the various Governments concerned, and they sometimes choose to use the aid funds for other purposes.

Unidentified Flying Objects: Sightings

3.4 p.m.

The Earl of Clancarty: My Lords, I beg leave to ask the Question which stands in my name on the Order Paper.

The Question was as follows:

To ask Her Majesty's Government how many reports have been received by the Ministry of Defence on unidentified flying objects (UFOs) in each of the last four years, and what action has been taken in each case.

Viscount Long: My Lords, in 1978 there were 750 sightings; in 1979 there were 550 sightings; in 1980, 350 sightings; and in 1981, 600 sightings. All UFO reports are passed to operations staff who examine them solely for possible defence implications.

The Earl of Clancarty: My Lords, while thanking the noble Viscount for that Answer, may I ask him whether or not it is a fact that over 2,000 authenticated UFO reports were published last year in the national press? If so, were they accepted or passed on to the Ministry of Defence? And what happened to them?

Viscount Long: My Lords, they did not all get to the Ministry of Defence. I have just informed your Lordships of the numbers sighted. If the noble Earl is suspicious that the Ministry of Defence is covering up in any way, I can assure him that there is no reason why we should cover up the figures which he has mentioned if they are true. The sole interest of the Ministry of Defence in UFO reports is to establish whether they reveal anything of defence interest—for example, a Russian aircraft or an unidentified aircraft—which might have breached our security systems. That is the sole reason why we are interested in the reports.

Lord Wynne-Jones: My Lords, does the Answer given mean that since there has been a Conservative Government the UFOs have done a U-turn and departed?

Viscount Long: Not according to my reading, my Lords.

The Earl of Kimberley: My Lords, as my noble friend said that 600 UFOs had been officially reported or acknowledged by the Ministry of Defence in 1981, may I ask him how many of those sightings still remain unidentified and were not subject to security, or were Russian aeroplanes, or anything like that?

143

Lord Straboigi: My Lords, may I ask the noble Viscount whether the present Government adhere to the view of the previous Government which I put forward when I replied to the debate three years ago in your Lordships' House, that most of these so-called sightings can be accounted for as natural phenomena?

Viscount Long: Yes, my Lords, they can be. Many of them are accounted for in one way or another, but nobody has got a really constructive answer for all of them.

Lord Hill-Norton: My Lords, may I ask the noble Viscount whether or not it is true that all the sighting reports received by the Ministry of Defence before 1962 were destroyed because they were deemed "to be of no interest"? And if it is true, who was it who decided that they were of no interest?

Viscount Long: My Lords, my reply to the noble and gallant Lord—I was wondering whether he was going to say that the Royal Navy had many times seen the Loch Ness monster—is that since 1967 all UFO reports have been preserved. Before that time, they were generally destroyed after five years.

Lord Paget of Northampton: My Lords, can the noble Viscount tell us whether, out of these thousands of sightings which he has mentioned, there has been a single one which suggested any menace to our defences? In the circumstances, is not an awful lot of time being wasted on this nonsense?

Viscount Long: My Lords, I think Her Majesty's Government are waiting for an invitation from them to discuss these problems.

Mr. Anatoly Shcharansky: Representations

3.9 p.m.

Lord Renton: My Lords, I beg leave to ask the Question which stands in my name on the Order Paper.

The Question was as follows:

To ask Her Majesty's Government whether they are aware that Anatoly Shcharansky has for the past 15 months been undernourished, tortured and frequently placed in punishment cells, and in October 1981 had his prison sentence increased by 3 years for his refusal to plead guilty to a charge of which he has always maintained his innocence; and whether they will request the Soviet Government to state whether they intend to keep him in those uncivilised conditions until he relents or dies.

Lord Trefgarne: My Lords, Her Majesty's Government remain gravely concerned about the plight of Anatoly Shcharansky and are disturbed by recent reports of his ill-treatment. We have raised this case with the Soviet authorities on many occasions, both

meeting: We shall continue to take a close interest in Mr. Shcharansky's case, and to make representations as suitable opportunities arise.

Lord Renton: My Lords, may I thank my noble friend not only for that Answer but for the action which he and the Foreign Office have been and are taking with regard to Shcharansky's plight? May I ask my noble friend whether or not the Soviet Government's failure, as shown by the treatment of Shcharansky and others, to honour their Helsinki undertakings diminishes their credibility in relation to all other matters in which they say they are seeking agreement and on which they would like to be believed?

Lord Trefgarne: If I may say so, my Lords, my noble friend has put his finger on the nub of the problem. How can we believe what they say in negotiations such as the IMF negotiations, the MBFR negotiations as they are called in Vienna, or in any other forum for that matter, when they do not do what they said they would do at Helsinki in 1976?

Lord Shinwell: My Lords, in view of the rumours, which are probably well founded, that Mr. Brezhnev is about to retire, could a message from your Lordships' House be sent to him through the Soviet Embassy wishing him for the remainder of his life—and we hope he has many years left yet—peace and contentment and asking whether, as a gracious act upon his retirement, he will ensure that Mr. Shcharansky is treated as a civilised person?

Lord Trefgarne: My Lords, I would certainly be willing to send another message to the Soviet Union about Mr. Shcharansky if I thought it would have any effect. As to the future of Mr. Brezhnev, I believe that that is a matter for them to decide for themselves.

Viscount Mountgarret: My Lords, would it not help if the western nations ceased providing wheat to the Soviet Union, at a time when they are finding themselves short, until they cease to carry out such inhuman activities against individuals and sovereign States?

Lord Trefgarne: My Lords, the failure of the Soviet agricultural industry is now plain for all to see, but I am not sure that the interests of the West are served by starving them out.

Lord Elwyn-Jones: My Lords, in view of the fact that the treatment of Shcharansky seems to be a serious violation of human rights, has the matter been raised before the sub-commission on human rights at the United Nations?

Lord Trefgarne: My Lords, I am not certain that the matter has been raised before that particular body but certainly it has been raised before all the others I mentioned. There could be a good opportunity for doing as the noble and learned Lord suggests.

Lord Avebury: My Lords, is the Minister aware that Mr. Shcharansky is a very distinguished computer scientist? Will he therefore consider a reduction in

M1

7608c
A/E
(E83)

Priority

This non-oral question has been allocated to Minister(AF) for answer.

2. Would you please supply a draft reply and background note, together with any relevant Hansard extracts and Press cuttings, to reach this office at the time shown on the front cover.
3. Please submit a copy of the draft answer to PS/USofS(AF) when returning this, allowing sufficient time for USofS(AF) to comment.

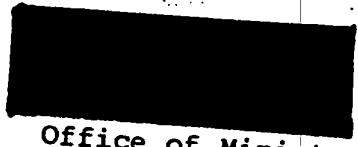

Office of Minister(AF)
Room 6386 Main Building

21.10.83

M2

APS/Minister(AF) (thro' DUS(Air))

Copy to:
APS/US of S(AF)
Ops(GE)2(RAF)

1. I have placed opposite a draft reply to PQ 7608C.
2. The same background note has been provided for PQ 7607C and PQ 7609C.

21 October 1983

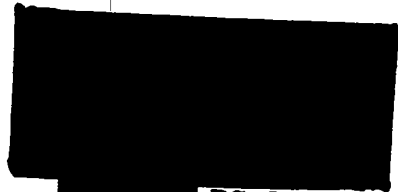

DS 8
MB 7257

145

C82

PQ 7608C

SIR PATRICK WALL (CONSERVATIVE) (BEVERLEY)

Sir Patrick Wall

- To ask the Secretary of State for Defence whether, in view of the fact that the United States' Air Force memo of 13 January 1981 on the incident at RAF Woodbridge has been released under the Freedom of Information Act, he will now release reports and documents concerning similar unexplained incidents in the United Kingdom.

SUGGESTED ANSWER (Mr Stanley)

This has been considered. It is the intention to publish reports.

(81)

Background Note

These three questions follow from the News of the World article of 2 October 1983 (Annex A) describing an alleged UFO sighting by USAF personnel at RAF Woodbridge in Suffolk on 27 December 1980.

The report of 13 January 1981 (Annex B) examined by the Air Staff and DS 8. It was concluded that there was nothing of defence interest in the alleged sighting.

There was, of course, no question of any contact with "alien beings" nor was any unidentified object seen on any radar recordings, as alleged in the News of the World.

A BBC investigation into the incident following publication of the News or the World Article concluded that a possible explanation for the lights seen by the USAF personnel was the pulsating light of the Orfordness lighthouse some 6 - 7 miles away.

The sole interest of the MOD in UFO reports is to establish whether they reveal anything of defence interest (eg intruding aircraft). MOD investigations are not pursued beyond the point at which we are satisfied that a report has no defence implications. No attempts are made to identify and catalogue the likely explanation for individual reports.

Last year, Lord Long, during a debate initiated by the Earl Clancarty, said that he would look into the possibility of publishing such reports as are received by the Ministry of

Defence. US of S(AF) has now decided to release compilations of reports. They will be published on a quarterly basis and will be available to members of the public, at a small charge to cover costs. US of S(AF) had planned to make an announcement shortly in the House of Lords through an arranged PQ. Pending arrangements for an announcement in the Lords, US of S(AF) has agreed that we should indicate the decision in the Commons.



Defence Secretariat Division 6
MINISTRY OF DEFENCE
Main Building Whitehall London SW1A 2HS

Telephone 01-218 (Direct Dialling)
01-218 9000 (Switchboard)

(P) (E-7)

[REDACTED]

Your reference

Our reference
D/DS8/10/209

Date

19 October 1983

[REDACTED]

Thank you for your letter of 9 October concerning the alleged UFO landing near RAF Woodbridge.

I should explain that it is not the policy of the Ministry of Defence to release its files to members of the public. All MOD files are subject to the provisions of the Public Records Act which lay down that in general official files are to remain closed until 30 years have elapsed after the last action taken on them. It would not, therefore, be possible to accede to your request.

I can, however, confirm that no unidentified object was seen on any radar recordings during the period in question and that the News of the World article was inaccurate on this point.

Yours sincerely
P. J. Titchmarsh
P J TITCHMARSE (Mrs)



Defence Secretariat Division 8a
MINISTRY OF DEFENCE
Main Building Whitehall London SW1A 2HB
Telephone 01-218 (Direct Dialling)
01-218 9000 (Switchboard)

(F)
(E73)



Your reference

Our reference
D/DS8/10/209
Date
19 October 1983



Your letter of 2 October has been passed to me for reply.

I can confirm that the Ministry of Defence did receive a report from base personnel of a UFO sighting near RAF Woodbridge on 27 December 1980. (This was the report published by the News of the World on 2 October 1983). The report was dealt with in accordance with normal procedures i.e. it was passed to staff concerned with air defence matters who examine such reports to satisfy themselves that there are no defence implications. In this instance MOD was satisfied that there was nothing of defence interest in the alleged sightings. There was no question of any contact with "alien beings" nor was there any confirmation that an object had landed in the forest.

You may be interested to know that the BBC recently carried out its own investigations into the incident and concluded that the UFO was nothing more sinister than the pulsating light of the Orfordness Lighthouse some 6 or 7 miles away through the trees.

Yours sincerely
P. J. G. Titchmarsh

P J TITCHMARSH (MRS)

150

Rm 7230.

DEFENCE
D.S. 8
12 OCT 1983

FILE 10/209

RAF Press Office
Ministry of Defence
Whitchall
London SW1A 2HB

01 - 568 6100

1983 October 9

Dear Sirs,

As you may have seen on BBC TV's Breakfast Time programme on Friday October 7, I visited the site of the alleged UFO landing outside Woodbridge Air Force station in Suffolk and found that the pulsating bright light seen among the trees was apparently nothing more alien than the lighthouse at Orford Ness, which does indeed illuminate the forest near Woodbridge with a white light, as the letter from USAF Lt Col Charles Halt describes.

In view of the immense public interest in this case following the News of the World article (and, I believe, further coverage this week), and mindful of the fact that it would be important to establish the lighthouse theory if it is true, I wonder if you would now consider releasing the MoD investigation file on this case, as I understand that you have done with other cases before now? I would certainly be prepared to pay any reasonable administration charge that this might entail.

I should also welcome comments on the apparent radar sighting of a UFO at about the time of the Woodbridge incident.

Yours sincerely,

[Redacted signature block]

1209
I suggest a minor amendment to the defense line,
70 otherwise fine. Pl. you attend. July 6/10.
E66

News of the World Article on UFOs.

We spoke yesterday about the attached article. I have since instituted investigations and attach a press line and Q&A brief which I propose sending to the DPO. This will hopefully put them on the right track should there be further inquiries.

The News of the World story appears to be one fabrication after another. Lt. Col. Halt has not spoken to anyone from the News of the World nor has he been told his career would be in jeopardy if he talked about the incident. The report has not been classified top secret by the USAF - the only report prepared by the USAF is that contained on our files and which is unclassified!

The alleged interview with Sqn. Ldr. Moreland is also a fabrication. He stated that "to the best of my knowledge Lt. Col. Halt is a very genuine person" but gave no details of any conversation he had had with Halt nor did he say "Whatever it was, it was able to perform feats in the air which no known aircraft is capable of doing."

As regards the information allegedly provided by the former security policeman this is completely untrue. The personnel who went into the forest to investigate the lights went on foot - not in a jeep. Only three patrolmen entered the forest, contrary to the report of more than 200 RAF and USAF personnel being present. There was never any question of alien beings. Nor is there any truth in the statement that "Art Wallace" and others were interviewed.

US authorities did not carry out any such investigations but left MOD to carry out its own investigations.

Ops (GR) has checked the question of radar traces with NATO who have informally stated that nothing was seen on any radar recordings although they did receive a report of a sighting for a civil aircraft.

The unfortunate point about the article is the fact that MOD refused to comment on the grounds that it was a matter for the USAF while USAF were saying it was a matter for MOD - an ideal support to the theory of a MOD cover up!

R
3/10

LOOSE MINUTE

D/DS8/10/209-1386

6 Oct 83

DPO(RAF)

NEWS OF THE WORLD ARTICLE: UFO SIGHTING AT
RAF WOODBRIDGE

1. Following the coverage given by the News of the World on 2 October 1983 to the alleged UFO Sighting at RAF Woodbridge on 27 December 1980 and the follow-up promised for 9 October we have drawn up a defensive press line and short Q & A brief for use by yourselves.
2. If you receive further enquiries from the press which you are unable to answer from the briefing provided please do not hesitate to contact me. The report in the News of the World that MOD and USAF both referred callers to the other will have done nothing but confirm suspicions widely held in UFO circles that we are engaged in a cover-up!

P.J. Titchmarsh.

P J TITCHMARSH(Mrs)
DS8a
MB 7230 2638 MB

Defensive Press Line

I can confirm that the Ministry of Defence did receive a report from base personnel of a UFO sighting near RAF Woodbridge on 27 December 1980. (This report was published by the News of the World on 2 October 1983). The report was dealt with in accordance with normal procedures i.e. it was passed to staff concerned with ^{our} defence matters who examine such reports to satisfy themselves that there are no defence implications. In this instance MOD was satisfied that there was nothing of defence interest in the alleged sightings. There was no question of any contact with "alien beings".

Q1. Did the US authorities investigate the incident?

A1. No. Once the report had been sent to the Ministry of Defence the US authorities carried out no further investigations. [Investigations of UFO reports in the UK are carried out by the Ministry of Defence; the USAF has no responsibility in such matters].

Q2. Was Col Halt told to keep quiet?

A2. No. Lt Col Halt has not been told to keep quiet about the incident nor has he been informed that his career could be in jeopardy.

Q3. Was the object tracked on radar?

A3. No. No unidentified object was seen on any radar recordings during the period in question.



Earthly beings: Mr Vincent Thurkettle and his dog at the forest site of the Christmas UFO "landing".

Down to earth approach to a UFO

From Alan Hamilton, Woodbridge

The mission was to seek a close encounter, preferably of the third kind, but any kind would do.

The place was a vast clearing deep in the 10,000 acres of Aldewood Forest, Suffolk, where, according to yesterday's *News of the World*, an alien spacecraft landed at Christmas, 1980, flew among the trees, left imprints on the ground, and vanished only when the United States Air Force from Woodbridge base, half a mile away, came out to investigate.

Witnesses, according to the paper, have since greatly elaborated on the event, speaking of beings in silvery suits who practised levitation.

The first being encountered yesterday was clad in corduroy trousers and black wellingtons. He came, he said, not from outer space, but the Forestry Commission. His name was not the Mekon, but Vincent Thurkettle.

The second being closely resembled a collie dog, and was too busy chasing sticks to levitate.

"This is the site", said the first being, gesturing around a rough acreage of stumps and teigs. "When the UFO is supposed to have landed the whole area was covered by Corsican pines 75ft tall and only 10ft apart. It would have

taken a fair feat of navigation to get among that lot."

He pointed to indentations in the ground that might have been made by the feet of a far-travelled craft. "Rabbits", he said. "They dig for roots."

But, surely, the searchers reported burn marks on the surrounding trees and radiation in the ground?

"The burns were the marks we put on the trees for felling. And as for radiation, a craft from outer space is going to use a far more sophisticated form of propulsion."

A third being, who said he was David Boast, and a gamekeeper, was quoted in the *News of the World* as saying

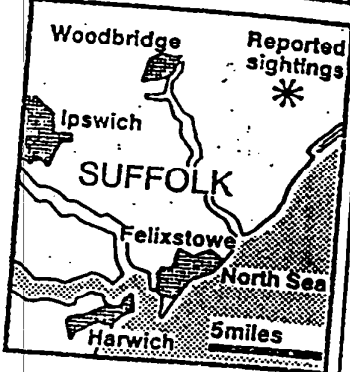

how cattle panicked near his house on the night in question. "There are no cattle anywhere near here", he told me. "This is a forest."

Neither the first nor the third being could recall anything untoward on the night in question, except that it was Christmas.

Tory move on holiday vote law

By Our Political Reporter
The Government is expected to announce next week that it will legislate to give holiday-makers postal votes at the next general election. Ministers and MPs were back during the general election campaign by the dissatisfaction of those who were going on holiday on June 9 and not allowed a vote. A flood of resolutions from Tory associ-

Thatcher third term aims may be restated

Conservative MPs believe that Mrs Margaret Thatcher may soon be stung into restating her determination to lead the party for a third term of office.

This follows several reports suggesting that some MPs are privately expressing the view that she may stand down, an opinion voiced for the first time publicly on Saturday by a leading backbencher, Mr Julian Critchley.

Margaret, those that loathe her and me."

Asked if he was thinking in terms of a successor Mr Critchley replied: "Increasingly so". He went on: "I think she will not run for a third full term in 1987-88."

Questioned later he speculated on possible successors, saying: "If the leadership were to change at this point in time it would be Sir Geoffrey Howe who would be the favourite."

Hardliners in SNP keep power

The levers of power in the Scottish National Party remain firmly in the hands of the hardline "independence, nothing less" faction. Elections held at the end of the party's forty-ninth annual conference, on the island resort of Rothesay at the weekend, produced almost a clean sweep of the important party offices for the traditionalists.

Red war of words on our students

By GRAEME GOURLAY

RUSSIA is using British university radio stations in a major propaganda campaign.

For the past two years State-run Radio Moscow has been sending tapes of news and arts programmes to most of the 19 campus radio stations run by students.

Many of these stations, which are licensed by the Home Office have broadcast the propaganda tapes unedited. But others have refused to use the heavy-handed and biased reports.

Last week, while Mrs Thatcher was calling on the West to 'fight a battle of

RUSSIA 'ideas' against Communism, two-thirds of the campus radio stations were getting free tapes from Moscow.

Among those sent to Nottingham University were Soviet Viewpoint, Soviet Press Review and Life in the USSR.

Programme controller Jeff Owen said yesterday: 'We get about five tapes a week. We occasionally use them — mainly the arts and cultural programmes. Of course, some is just boring propaganda but other bits are quite interesting.'

Stirling University's manager Doug Morris said the tapes were 'pretty atrocious' but they were used now and then.

But at Kent University, a student spokesman said: 'We were asked by

Radio Moscow if we wanted the tapes and turned them down straight away.'

A typical example is this extract from Soviet Press Review: 'After the deliberate provocation with the South Korean plane it must seem that the Reagan administration has beaten all records of hypocrisy and distortion of facts. Yevgeniy Ruschov says in Pravda.'

Moscow is pouring millions of roubles into its battle with Western broadcasting, spending more in four days jamming the BBC World Service transmissions to the Soviet Union than the BBC Russian service's annual budget.

● Anti-Western propaganda could be beamed on future satellite TV to British homes because of a loophole in international law on copyright.

SUNDAY PEOPLE

UFO DID NOT LAND IN SUFFOLK

CLAIMS that a UFO landed in an East Anglian pine forest were dismissed as "pie in the sky," last night.

The mysterious craft is said to have landed near an American Airforce base at Woodbridge, Suffolk, two years ago.

It lit up the whole of nearby Bingham Woods with a dazzling white light.

But when two American airman on guard duty went to investigate,

and that's official

the "hovering object" suddenly sped away and vanished.

Later, there was talk of silvery beams emerging from a 30ft wide flying saucer, burn marks on trees and strange lines in the ground.

The strange affair is recounted in a new book written by a member of the British UFO Society.

But Forestry Commission officer Vince Thirkettle, who lives near the woods, said: "I carried out my own investigation and I am satis-

fied the so-called evidence was blown up out of all proportion.

"The burns were made by a forester to mark out trees for felling and depressions in the ground looked like rabbit scrapings.

"I have lived and worked in the forest for five years and I've never seen any spacemen. It's more pie in the sky than flying saucers."

A police spokesman said: "American flyers often drop parachute flares which people mistake for UFOs."

(18)

157

TT

E65

I saw UFO land / — American officer

A SENIOR American Air Force officer reported sighting a UFO landing in Suffolk during Christmas 1980, the Ministry of Defence confirmed last night.

Lieut-Colonel Charles L. Holt, deputy commander of the USAF 81st Tactical Wing at RAF Woodbridge, told of seeing a "red, sun-like light" near the air base in the early hours of December 27.

A Defence Ministry spokesman said: "There was a 'sighting' by an officer in the USAF. He was off-duty and off the base. He made a report and submitted it via the RAF commander at

Woodbridge to the Ministry of Defence."

Sir John Nott, who became Minister of Defence within a fortnight of the reported sighting, said last night: "I know nothing about it. Certainly I never saw any reports about a UFO landing. I don't believe in UFO's, anyway."

Another former Minister of Defence, Sir Ian Gilmour, said: "I should think this is absolute rubbish."

SUNDAY MIRROR

FLYING² SAUCER 'LANDS IN BRITAIN'

Sunday Mirror Reporter

A FLYING saucer landed on a top secret American air base in an English forest, says an amazing report just released by US air force chiefs.

They say the UFO "ringed with portholes and blue flashing lights" came down on the main runway of USAF Woodbridge, Suffolk.

It zoomed over Tangham Forest three nights in succession, and landed "at least once".

The huge metallic craft was spotted by guards who found deep impressions on the ground. Unexplained radiation was also reported nearby.

The incredible documents, drawn up by USAF Colonel Charles Holt, says the sightings were reported to the Pentagon three years ago.

They have come to light now after the release of classified documents.

Forestry workers yesterday told of "strange, unconfirmed reports" of a UFO in the area.

NEWS OF THE WORLD

We must¹² be told.

SOMETHING strange happened out there in the forest on that wintry night in December, 1980.

Our fully documented Page 1 report of a UFO landing in Suffolk cannot be shrugged away.

At every turn our investigators met an official wall of silence—yet nobody disputed the basic facts.

Someone in authority, particularly in the Ministry of Defence has the answer.

It is time we were told.

(20)

158

15



DEPARTMENT OF THE AIR FORCE
HEADQUARTERS THIRD AIR FORCE (USAFE)
RAF MILDENHALL, SUFFOLK IP28 8NF

6159

3AF/10/1/Org

Mildenhall 712511 ext 2821

MOD(DS8a)
Main Building
Whitehall
London
SW1A 2HB

15 Apr 83

MINISTRY OF DEFENCE
D. S. B.
18 APR 1983
FILE 15/209

UNIDENTIFIED FLYING OBJECT

Reference:

A. D/DS8/10/209 dated 11 April 1983.

1. Thank you for your letter at Reference and the Enclosure from [REDACTED]
2. The radar at Upper Heyford did not track an unidentified flying object on 15 March 1983 as alleged. As reported to me the events were as follows:

Just after dusk, a local reporter for the Reading Evening Post telephoned the tower at Upper Heyford and asked if they could see "lights" at the opposite side of the airfield. The controllers assistant, after checking, told the reporter that the duty crew could indeed see the "lights" and that they did not know what they were-but they could have been some airfield lights, traffic within the airfield or traffic outside the airfield. The telephone conversation then terminated.

3. The US authorities at Upper Heyford reiterate that at no time did they track on the airfield radar any unidentified target. It is my belief that the reporter in question did not ask the right questions in the first place and has completely misinterpreted the answer he received.

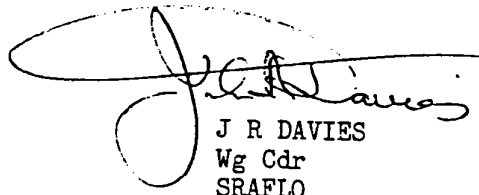
J R DAVIES
Wg Cdr
SRAFLO



159



RAF LIAISON OFFICE
 Royal Air Force Bentwaters Woodbridge Suffolk IP12 2RQ
 Telephone Woodbridge 3737 ext 2381 2257

10/209
 122RQ
 2

MOD(DS8c)

(Attn: Mr P D Watkins)

Your reference

Our reference
 BENT/19/76/Air

Date

9 May 1983

Dear Peter,

The UFO sighting in the Rendlesham Forest continues to excite attention. For your information I enclose copies of the latest newspaper articles on the subject.

*Sincerely,
 Ian Mowbray*

Mystery of alleged UFO landing in forest

CLAIMS that an extra-terrestrial trio with a faulty flying saucer have visited Suffolk are being probed by UFO investigators.

Officialdom, they claim, has drawn a shroud of secrecy around the alleged incident apart from a Defence Ministry letter which has given the probe fresh headway.

WITNESS

Investigators Dot Street and Brenda Butler are trying to unravel what has become known in UFO enthusiasts' circles as the Rendlesham Forest Mystery.

They say their inquiries have included a graphic

description of the alleged night-time incident given to them by an eye-witness U.S. serviceman. The name of their key witness however is a closely guarded secret they guaranteed him anonymity when he recounted his unearthly claims.

His amazing allegation is that three "entities" were seen with their spacecraft which had landed about two miles from Woodbridge Airbase in a remote part of Rendlesham Forest.

He claims they were about three feet tall, dressed in silver suits and were "levitating" in shafts of light.

The key witness, who has

since returned to the United States, claimed that an un-armed party of base personnel watched the visitors carry out repairs to their craft which later took off.

Dot and Brenda told the Woodbridge Reporter that their 2½ year probe was being hampered by a top level hush-hush policy.

"We have contacted the USAF and the Ministry of Defence time and time again but they just will not tell us anything," said Dot, who is area investigator for the British UFO Research Association.

"They will not deny that anything happened that night, but on the other hand

that will not say much at all about it," she said.

"If it was something to do with an aircraft or anything like that why don't they tell us as much and we would leave it alone... all I am a UFO investigator."

LIGHTS

Last month however the investigation made some headway. The Ministry of Defence conceded in a letter that "unusual lights" were seen near the base at the time of the alleged incident — late December 1980.

The letter said, "I can confirm that USAF personnel did see unusual lights outside the boundary fence in the early morning of December 27, 1980, but no explanation for the occurrence was ever forthcoming."

There was "no question" of there being a cover-up for a crashed aircraft or the testing of "secret devices" — which was suggested by Dot and Brenda.

The letter concluded, "Nor was there any contact with 'alien beings'."

LETTER

Until the letter was received the Ministry had simply replied to inquiries with a blunt "We cannot help you in your quest" reply, said Dot and Brenda.

A Defence Ministry spokesman told the Woodbridge Reporter that reports of unexplained lights in the area at the time were investigated.

"We are certainly interested in sightings of anything unusual in so far as any

concerned. When we have satisfied ourselves through our sources and our own investigations that there was no security implications we are no longer interested.

"In this particular case we were satisfied that that was the case."

A USAF spokesman said, "Everytime I hear about this it becomes more elaborated. All we know is that some people on duty that night saw some lights in the sky which I understand were seen in other parts of the country too.

"We know of nothing else but people always think we are hiding something when we say that, but we are not."

Whatever the answer Dot and Brenda plan to continue their probe and are preparing a book about it which they hope will be published next year. The appeal for information on the alleged incident and guaranteed that all calls would be treated in confidence.

Dot can be contacted on Lowestoft 84606 and Brenda can be contacted on Leiston 830757.

Slow start by voters

Voting in the Woodbridge area got off to a slow start in yesterday's local government elections, and the area's tradition of a low turn-out at such polls looked set to be upheld.

All the results will be published in next week's issue of the Woodbridge

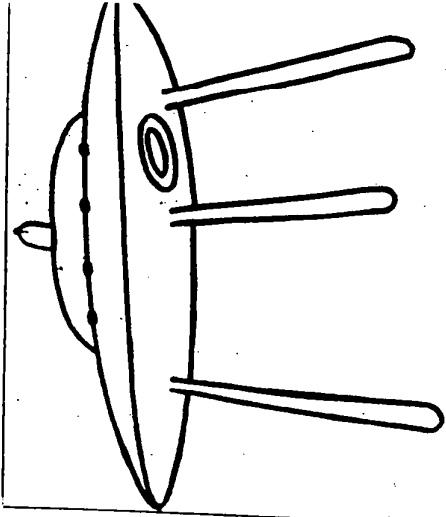

A copy of the eye witness's drawing of the crash site he claimed to have seen in Rendlesham Forest. Estimated width was 30 feet.



Brenda Butler (left) and Dot Street on the site of the alleged landing of the space ship in Rendlesham Forest.

WOODBIDGE REPORTER
Friday, 6 May 83
FRONT PAGE

Duo still on trail of mysterious 'U.F.O. landing' in forest

CLAIMS that an extra-terrestrial trio with a faulty flying saucer have visited Suffolk are being probed by UFO investigators.

Officials they claim, has drawn a shroud of secrecy around the alleged incident near the RAF base at Woodbridge... but now a Defence Ministry letter has given the probe fresh headway. The Ministry has conceded that "unusual lights" were

has become known in UFO enthusiasts' circles as the Rendlesham Forest Mystery.

They say their inquiries have included a graphic description of the alleged night-time incident given to them by an eye-witness U.S. serviceman. The name of their key witness however is a closely guarded secret... they guaranteed him anonymity when he recounted his unearthly claims.

His amazing allegation is that three "entities" were seen with their spacecraft which had landed about two miles

investigator for the British UFO Research Association.

"They will not deny that anything happened that night, but on the other hand they will not say much at all about it," she said.

"If it was something to do with an aircraft or anything like that why don't they tell us as much and we would leave it alone... all I am is an UFO investigator."

Until the letter was received the Ministry had simply replied to inquiries with a blunt "we cannot help you in your quest" reply, said Dot and Brenda.

A Defence Ministry spokesman told the Star that reports of unexplained lights in the area at the time were investigated. "We are certainly in-

terested in sightings of anything unusual in so far as any security implications are concerned. When we have satisfied ourselves through our sources and our own investigations that there was no security implications we are no longer interested.

"In this particular case we were satisfied that that was the case."

A USAF spokesman said, "Everytime I hear about this it becomes more elaborated. All we know is that some people on duty that night saw some lights in the sky which I understand were seen in other parts of the country too.

"We know of nothing else but people always think we are hiding something when we say that, but we are not."

Whatever the answer Dot and Brenda plan to continue their probe and are preparing a book about it which they hope will be published next year. They appealed for information on the alleged incident and guaranteed that all calls would be treated in confidence. Dot can be contacted on Lowestoft 84606 and Brenda can be contacted on Leiston 830757.

Story by JOHN GRANT

seen near the base at the time — late December 1980. The letter said, "I can confirm that USAF personnel did see unusual lights outside the boundary fence in the early morning of December 27, 1980, but no explanation for the occurrence was ever forthcoming."

Mystery

There was "no question" of there being a cover-up for a crashed aircraft or the testing of "secret devices".

The letter concluded, "Nor was there any contact with 'alien beings'".

But Suffolk investigators Brenda Butler and Brenda Butler are still trying to unravel what

from the Woodbridge airbase in a remote part of Rendlesham Forest. He claims they were about three feet tall, dressed in silver suits and were "levitating" in shafts of brilliant light. The key witness, who has since returned to the U.S., claimed that an unarmed party of base personnel watched the visitors carry out repairs to their craft which later took off. Dot and Brenda told the Star that their 2½ year probe was being hampered by a top level hush-hush policy. "We have contacted the USAF and the Ministry of Defence time and time again but they just will not tell us anything," said Dot, who is area

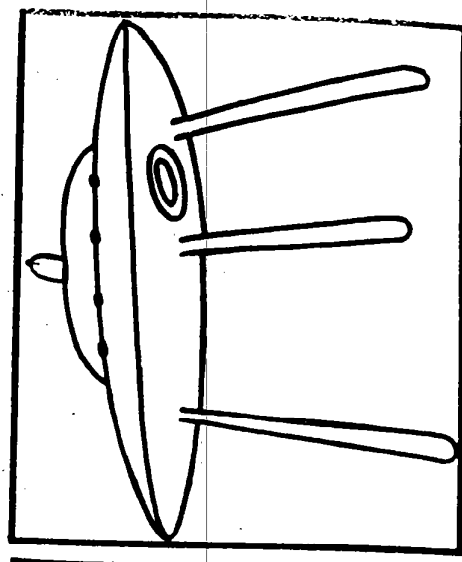

● The witness's drawing of the craft he claimed to have seen in Rendlesham Forest. Its estimated width was 30 feet.
● Brenda Butler, left, and Dot Street on the site of the alleged landing of the spaceship in Rendlesham Forest.

291



MINISTRY OF DEFENCE Defence Secretariat Division 8a
Main Building Whitehall London SW1A 2HB
Telephone 01-218 2638 (Direct Dialling)
01-218 9000 (Switchboard)

Wg Cdr J Davies
SRAFLO
RAF Mildenhall
Suffolk
IP28 8NF

Your reference

Our reference

D/DS8/10/209 -1401

Date

13 May 1983

Dear Jan

INCIDENT AT RAF WOODBRIDGE - DECEMBER 1980

1. Following our telephone conversation about the incident at RAF Woodbridge on 27 December 1980 I wrote to Miss Randles and I attach a copy of my letter.
2. You will see that she has now written again seeking further information about the incident and in particular has requested a copy of the report held on our files. The only report we have is that prepared by Lt Col Halt the Deputy Base Commander at RAF Woodbridge and I am therefore writing to ask you to seek the views of the USAF to disclosure of that report or a sanitised version of it. If the USAF would only be prepared to allow release of a sanitised version it would be helpful to know which parts they would wish me to delete. In addition, I would be grateful to know whether the USAF would be willing for me to say that they did investigate the incident.
3. Thank you for your assistance with the recent UFO correspondence.

Yours ever
Pam.

P J TITCHMARSH (MRS)

163



DEPARTMENT OF THE AIR FORCE

HEADQUARTERS THIRD AIR FORCE (USAFE)

RAF MILDENHALL, SUFFOLK IP28 9NT
DEFENCE

D.S.8
23 MAY 1983

FILE 10/209

E6/3
E6

3AF/12/Org

Mildenhall 712511 ext 2821

MOD(DS8)
Main Building
Whitehall
London
SW1A 2HB

18 May 83

INCIDENT AT RAF WOODBRIDGE - DECEMBER 1980

References:

- A. D/DS8/10/208 dated 13 May 1983.
- B. Telecon Davies/Titchmarsh PM 17 May 1983.

1. Thank you for your letter at Reference A and Enclosures. I said in the telephone conversation at Reference B that it will be some little time before we can get a decision on the release of the report by Lt Col Holt. In fact, the decision to allow the release might have to come from Secretary of State for Defence's office particularly if any security or intelligence implications are read into the reported sighting.

2. I will let you know of developments as they occur.

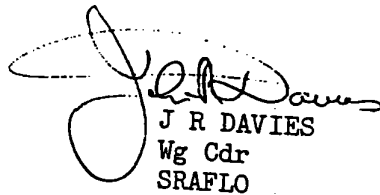
J R DAVIES
Wg Cdr
SRAFLO



READY THEN READY NOW

164



MINISTRY OF DEFENCE
Main Building Whitehall London SW1A 2HB
Telephone 01-218 (Direct Dialling)
01-218 9000 (Switchboard)

File.
[Handwritten scribbles]
EVI



Your reference

Our reference
D/DS8/10/209-1270
Date

13 April 1983



Thank you for your recent correspondence on the subject of UFOs.

As regards your offer to summarise the reports held by this Department there really is very little to summarise. I attach a copy of a blank report form showing the type of information we require together with a couple of examples of completed reports (with the name and address of the informant deleted for reasons of confidentiality). I am sure you will agree that, although we hold a large number of reports, each one is indeed very brief.

Turning now to your interest in the sighting at RAF Woodbridge in December 1980, I can confirm that USAF personnel did see unusual lights outside the boundary fence early in the morning of 27 December 1980 but no explanation for the occurrence was ever forthcoming. There is however, no question of the account being a cover-up for a crashed aircraft or testing of secret devices as you suggest, nor was there any contact with "alien beings".

I understand that an article on the Woodbridge sighting has been published in the magazine "OMNI" (Vol 5 No.6) in which you may be interested.

Yours sincerely
P.J. Titchmarsh.
P J TITCHMARSH (Mrs)

LOOSE MINUTE

6121

D/DS8/10/209 -1178

Ops(GE)(RAF)

UFO SIGHTING - RAF WOODBRIDGE DECEMBER 1980

1. You may recall that in December 1980 two USAF security patrolmen saw unusual lights at the back gate of RAF Woodbridge and on investigation found a brightly lit triangular object either hovering or on legs.
2. You began investigations into the incident and suggested asking the USAF for tape recordings (your D/DD Ops(GE)/10/8 of 16 Feb 81 refers) but unfortunately our files do not appear to show the outcome of your investigations.
3. I attach a copy of a letter received from one of our more regular UFO correspondents in which she seeks advice as to the Ministry's position on this incident. I am inclined to say that we are aware of the incident, that we made investigations but that we could find no explanation for the lights. Is this a true reflection of the facts or did we, in fact, come up with anything more substantive?
4. Any help you could give in replying to Miss Randle's letter would be much appreciated.

15 Mar 83

P. J. Titchmarsh

F J TITCHMARSH (Mrs)
DS8
MB 7230 2638 MB

166

February 28 1983

Dear Mrs Titchmarsh,

Further to your letter to me of 20 January 1983 (your ref: D/DS8/10/209); the subject UFOs. I trust you have received my subsequent letter to this (addressed to Peter Watkins) wherein I suggested that you might consider lodging the files you hold with a recognised scientific establishment. Here they could be accessible (an arrangement) to serious researchers, and their use could be adequately controlled. I really think this makes sense because the volume of data you must hold would make it very difficult to release other than summaries in printed form and often access to the full materials might be essential for scientific study.

A number of possible sources for locating these files, eg a university, come to mind. Indeed there have been a number of interested responses to the article on UFOs by myself and Peter Warrington (New Scientist, 10 Feb 1983) to which I refer you for illustration of my, hopefully, serious and non-sensationalist position on this topic.

I am well aware that to you UFO data is barely of interest and, as it does not seem to directly impinge on defence implications, of relatively low priority. However, I hope you also see that whilst 90% of these reports are unquestionably explicable there are reports that seem to offer probative data to scientists. Work that you, of course, have neither the facilities nor the resources to handle. It should be your concern that you hold this data, faithfully reported by individuals who would like something done. And I am delighted at your decision to make the material accessible for research.

Presumably it will be in your interests to cultivate a mood whereby UFO reports are not made to you, but to a scientific establishment (another advantage of lodging the files there). You could naturally rely upon the UFO community to transmit reports to you which might suggest defence implications. That is, if you are fair by serious investigators serious investigators will naturally be fair by you. And we too, of course, have the interests of Britain at heart and would not wish you to be unaware of any cases that might involve defence implications. Even though, as you have pointed out to me previously, none of your studies so far have produced such implications.

You have promised to advise me when you have taken a decision to release data, which is why I was somewhat surprised to learn that you have supplied to some colleagues of mine in Bristol data on cases in South Wales. I would, therefore, very much like an update on the current position please. For the last few years whilst writing to you I have stressed that I want to help put across your true position to the public (with which I have some influence as a full-time writer of UFO books and articles). But for this purpose I do need your help in return, of course. I see from the current issue of FLYING SAUCER REVIEW, for example, that much is said about your alleged cover-up and it is towards correcting this view with the facts (if you will openly give them) that I am concerned. Hence my previous requests to be granted access to the data prior to release so that I might present a fair review in the UFO literature and defuse such commentary.

Finally, on the question of defence implications, I would wish to advise you of an accretion of data concerning an incident which appears to have taken place at the US Air Force base at Woodbridge, Suffolk, in December 1980. It is of some concern to me that you have not been able to offer any statement on this event, because on face value the evidence does suggest that somebody is hiding something.

Now I have published some of the material supplied to me (and gathered myself) in the UFO literature, primarily because in lieu of any other reason I believe the information should be told. But understand my position here. I have no wish to do anything injurious to British defence and if I was offered any reason (however roundabout) which suggested the case should simply be dropped then I would do so. For example, it is possible that the UFO story is covering either an accident or

test of some secret device (either by British or American sources). Therefore, to continually stress this in a UFO context (which is how it has been reported) and yet inevitably have to mention such non-UFO explanations as these possibilities might be against this nations interests. Yet what else can I do, since I have no such reason to argue in this way and feel myself duty bound to discuss the matter in case it genuinely has gone un-noticed and yet may be of potential importance?

Very briefly, on this case, we have first-class hard evidence (which we could of course give to the national press but have had no desire to so do) that something occurred (during the last three days of the month, possibly December 29, 1980). This includes evidence of radar tracking of the unexplained object, its 'landing' in Rendlesham Forest and a number of independant testimonies that relate to a quite fantastic account of what supposedly happened after that. It is impossible for me and the couple of other people in possession of these full facts not to accept that a genuine event did occur and naturally we are more than a little concerned that (a) it has not been admitted to and (b) you profess to know nothing about it.

As I said, the evidence is strong (almost, I might say, categorically probative) and could (if we chose to discuss the full facts in the right way outside the limited circukation we have done so far) lead to quite an outcry about cover-ups. Personally, I believe you must have very good reason for doing what you are doing about this incident, and that may have nothing to do with UFOs per se. However, please see my position and recognise my dilemma. I want to do the right thing.

I am not expecting a reply saying anything specific about this event, but you may be able to offer advice about the problem I face. I have this data that seems probative. You do not seem to want it and claim to know nothing about it. I cannot just sit on it because it appears to be too important. Yet if I make a big issue out of it national security may suffer.

I would add that the story behind these events indicates that there was contact between military sources and an other intelligence (which is not alien spaeships in the nuts and bolts sense) but which is an indigenous intelligence to planet earth which in fact is way beyond us in terms of most capacities and therefore represent the real rulers of our world.

This account does merge with data offered by other sources to me (in confidence) including government officials in this country and abfoad. I have never published it and have actually played down the possibility in my books. I am not saying I believe it. But I am saying that I have heard it from so many dources that I do have to listen. And it does make a great deal of sense out of many things.

The UFO subject is complex and to represent it fairly very difficult. I so very much do want to do the right thing. But I am beginning to doubt if I am doing the right thing. Can you offer any advice?

Yours sincerely,

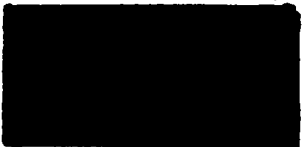



MINISTRY OF DEFENCE
Main Building Whitehall London SW1A 2HB
Telephone 01-218 2638 (Direct Dialling)
01-218 9000 (Switchboard)

FILE
E122
+1

Wg Cdr J Davies
SRAFLO
RAF Mildenhall
Bury St Edmunds
Suffolk

Your reference

Our reference

D/DS8/10/209-1177

Date

15 March 1983

Dear Sir

UFO SIGHTING - RAF WOODBRIDGE DECEMBER 1980

I attach a copy of a letter received from one of our more regular UFO correspondents regarding an incident at RAF Woodbridge in December 1980. I also attach a copy of the USAF report prepared after the incident.

I would be grateful if you could ascertain how far the USAF investigated the incident and what were the outcome of these investigations. I would also be grateful if you could find out what has been the USAF's public line on the incident and whether they have denied knowledge of it as suggested by Miss Randles.

Any help you can provide in replying to [REDACTED] letter would be much appreciated.

Yours sincerely
Pam Titchmarsh

P J TITCHMARSH (MRS)

169

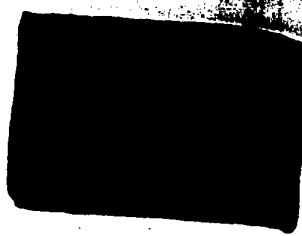
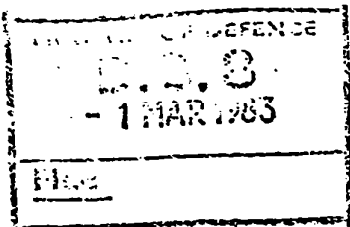

February 28 1983

Dear Mrs Titchmarsh,

Further to your letter to me of 20 January 1983 (your ref: D/DS8/10/209); the subject UFOs. I trust you have received my subsequent letter to this (addressed to Peter Watkins) wherein I suggested that you might consider lodging the files you hold with a recognised scientific establishment. Here they could be accessible (on arrangement) to serious researchers, and their use could be adequately controlled. I really think this makes sense because the volume of data you must hold would make it very difficult to release other than summaries in printed form and often access to the full materials might be essential for scientific study.

A number of possible sources for locating these files, eg a university, come to mind. Indeed there have been a number of interested responses to the article on UFOs by myself and Peter Warrington (New Scientist, 10 Feb 1983) to which I refer you for illustration of my, hopefully, serious and non-sensationalist position on this topic.

I am well aware that to you UFO data is barely of interest and, as it does not seem to directly impinge on defence implications, of relatively low priority. However, I hope you also see that whilst 90% of these reports are unquestionably explicable there are reports that seem to offer probative data to scientists. Work that you, of course, have neither the facilities nor the resources to handle. It should be your concern that you hold this data, faithfully reported by individuals who would like something done. And I am delighted at your decision to make the material accessible for research.

Presumably it will be in your interests to cultivate a mood whereby UFO reports are not made to you, but to a scientific establishment (another advantage of lodging the files there). You could naturally rely upon the UFO community to transmit reports to you which might suggest defence implications. That is, if you are fair by serious investigators serious investigators will naturally be fair by you. And we too, of course, have the interests of Britain at heart and would not wish you to be unaware of any cases that might involve defence implications. Even though, as you have pointed out to me previously, none of your studies so far have produced such implications.

You have promised to advise me when you have taken a decision to release data, which is why I was somewhat surprised to learn that you have supplied to some colleagues of mine in Bristol data on cases in South Wales. I would, therefore, very much like an update on the current position please. For the last few years whilst writing to you I have stressed that I want to help put across your true position to the public (with which I have some influence as a full-time writer of UFO books and articles). But for this purpose I do need your help in return, of course. I see from the current issue of FLYING SAUCER REVIEW, for example, that much is said about your alleged cover-up and it is towards correcting this view with the facts (if you will openly give them) that I am concerned. Hence my previous requests to be granted access to the data prior to release so that I might present a fair review in the UFO literature and defuse such commentary.

Finally, on the question of defence implications, I would wish to advise you of an accretion of data concerning an incident which appears to have taken place at the US Air Force base at Woodbridge, Suffolk, in December 1980. It is of some concern to me that you have not been able to offer any statement on this event, because on face value the evidence does suggest that somebody is hiding something.

Now I have published some of the material supplied to me (and gathered myself) in the UFO literature, primarily because in lieu of any other reason I believe the information should be told. But understand my position here. I have no wish to do anything injurious to British defence and if I was offered any reason (however roundabout) which suggested the case should simply be dropped then I would do so. For example, it is possible that the UFO story is covering either an accident or

test of some secret device (either by British or American sources). Therefore, to continually stress this in a UFO context (which is how it has been reported) and yet inevitably have to mention such non-UFO explanations as these possibilities might be against this nations interests. Yet what else can I do, since I have no such reason to argue in this way and feel myself duty bound to discuss the matter in case it genuinely has gone un-noticed and yet may be of potential importance?

Very briefly, on this case, we have first-class hard evidence (which we could of course give to the national press but have had no desire to so do) that something occurred (during the last three days of the month, possibly December 29, 1980). This includes evidence of radar tracking of the unexplained object, its 'landing' in Rendlesham Forest and a number of independant testimonies that relate to a quite fantastic account of what supposedly happened after that. It is impossible for me and the couple of other people in possession of these full facts not to accept that a genuine event did occur and naturally we are more than a little concerned that (a) it has not been admitted to and (b) you profess to know nothing about it.

As I said, the evidence is strong (almost, I might say, categorically probative) and could (if we chose to discuss the full facts in the right way outside the limited circukation we have done so far) lead to quite an outcry about cover-ups. Personally, I believe you must have very good reason for doing what you are doing about this incident, and that may have nothing to do with UFOs per se. However, please see my position and recognise my dilemma. I want to do the right thing.

I am not expecting a reply saying anything specific about this event, but you may be able to offer advice about the problem I face. I have this data that seems probative. You do not seem to want it and claim to know nothing about it. I cannot just sit on it because it appears to be too important. Yet if I make a big issue out of it national security may suffer.

I would add that the story behind these events indicates that there was contact between military sources and an other intelligence (which is not alien spaceships in the nuts and bolts sense) but which is an indigenous intelligence to planet earth which in fact is way beyond us in terms of most capacities and therefore represent the real rulers of our world.

This account does merge with data offered by other sources to me (in confidence) including government officials in this country and abroad. I have never published it and have actually played down the possibility in my books. I am not saying I believe it. But I am saying that I have heard it from so many sources that I do have to listen. And it does make a great deal of sense out of many things.

The UFO subject is complex and to represent it fairly very difficult. I so very much do want to do the right thing. But I am beginning to doubt if I am doing the right thing. Can you offer any advice?

Yours sincerely,



DEPARTMENT OF THE AIR FORCE
HEADQUARTERS 81ST COMBAT SUPPORT GROUP (USAF)
APO NEW YORK 09155



REPLY TO
ATTN OF: CD

13 Jan 81

SUBJECT: Unexplained Lights

TO: RAF/CC

1. Early in the morning of 27 Dec 80 (approximately 0300L), two USAF security police patrolmen saw unusual lights outside the back gate at RAF Woodbridge. Thinking an aircraft might have crashed or been forced down, they called for permission to go outside the gate to investigate. The on-duty flight chief responded and allowed three patrolmen to proceed on foot. The individuals reported seeing a strange glowing object in the forest. The object was described as being metallic in appearance and triangular in shape, approximately two to three meters across the base and approximately two meters high. It illuminated the entire forest with a white light. The object itself had a pulsing red light on top and a bank(s) of blue lights underneath. The object was hovering or on legs. As the patrolmen approached the object, it maneuvered through the trees and disappeared. At this time the animals on a nearby farm went into a frenzy. The object was briefly sighted approximately an hour later near the back gate.
2. The next day, three depressions 1 1/2" deep and 7" in diameter were found where the object had been sighted on the ground. The following night (29 Dec 80) the area was checked for radiation. Beta/gamma readings of 0.1 milliroentgens were recorded with peak readings in the three depressions and near the center of the triangle formed by the depressions. A nearby tree had moderate (.05-.07) readings on the side of the tree toward the depressions.
3. Later in the night a red sun-like light was seen through the trees. It moved about and pulsed. At one point it appeared to throw off glowing particles and then broke into five separate white objects and then disappeared. Immediately thereafter, three star-like objects were noticed in the sky, two objects to the north and one to the south, all of which were about 10° off the horizon. The objects moved rapidly in sharp angular movements and displayed red, green and blue lights. The objects to the north appeared to be elliptical through an 8-12 power lens. They then turned to full circles. The objects to the north remained in the sky for an hour or more. The object to the south was visible for two or three hours and beamed down a stream of light from time to time. Numerous individuals, including the undersigned, witnessed the activities in paragraphs 2 and 3.

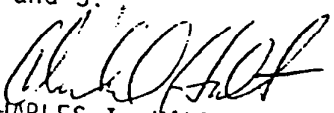
CHARLES I. HALT, Lt Col, USAF
Deputy Base Commander

172



MINISTRY OF DEFENCE
Main Building Whitehall London SW1A 2HB
Telephone 01-218 2638 (Direct Dialling)
01-218 9000 (Switchboard)

E2

Squadron Leader D H Moreland
RAF Commander
RAF Bentwaters
Woodbridge
Suffolk IP12 2RQ

Your reference

Our reference
D/DS8/75/2-794

Date

9 November 1982

Dear Squadron Leader Moreland

1. Thank you for your letter (Bent/19/76/Air) of 25 October and the attached article from 'The Unexplained' (the author is in fact one of my regular correspondents).
2. MOD's line on UFO's is as follows:-
 - a. Our sole interest in the UFO sightings reported to us is to check whether they have any relevance to the air defence of the UK.
 - b. Reports are referred to staff concerned with the air defence of the UK who examine them as part of their normal duties. Once they are satisfied that the sighting has no defence implications, they do not attempt to make a positive identification of the object.
 - c. While we recognise that there are many strange things to be seen in the sky, we believe that there are perfectly natural explanations for them - satellite debris, aircraft lights, etc. - and that there is no need to advance the hypothesis of alien spacecraft to account for them.
3. Concerning the Bentwaters UFO in particular, I suggest that you adopt the following line:
 - a. I understand that MOD did receive a report from base personnel of a UFO sighting near RAF Bentwaters on 27 December 1980. The report was dealt with in accordance with the normal procedures (see 2b above); it was not considered to indicate anything of defence interest.
 - b. There was no question of any contact with 'alien beings'.
4. As for the allegations in the article that the UFO story was simply a cover-up for a crash of an aircraft carrying a nuclear device, you may like to remind any questioners of the Written Answer given in Hansard for 28 January 1981 from Mr Pattie, then Under Secretary of State for the RAF: "No accidents have occurred involving ... damage to nuclear weapons containing fissile material on United Kingdom

... if they mention the Lakenheath incident, which
article drags in for good measure, again there is a Parliamentary
Statement on which you could draw, namely a Written Answer from
Mr Pym, then Secretary of State for Defence, on 9 November 1979:
"... the United States authorities have already stated that no
nuclear materials were involved either within the crashed aircraft
or in any buildings affected by the resulting fire". I would not
expect 'Ufologists' to pursue either of these angles any further;
if they do I suggest you refer them to us. Incidentally, it is
clear that the author did not look at a map if she supposes that
Lakenheath is "a few miles north" of Bentwaters!

5. I hope this is helpful to you and that Bentwaters does not
become East Anglia's answer to Warminster.

Yours sincerely,

Peter Wat



RAF LIAISON OFFICE
 Royal Air Force Bentwaters Woodbridge Suffolk IP12 2RQ
 18914
 Telephone Woodbridge 3737 ext 2257

Rep sent
 E132

MOD(DS8a)

MINISTRY OF DEFENCE
D.S.S
27 OCT 1982
FILE

Your reference

Our reference
 BENT/19/76/Air
 Date
 25 October 1982

UNIDENTIFIED FLYING OBJECTS (UFO's)

Reference:

A. BENT/19/76/Air dated 15 January 1981.

1. Under cover of reference A I forwarded you a copy of the Deputy Base Commander's report concerning some unexplained lights and sightings on 27/29 December 1980. Some time after the incident I was approached by two women who claimed to be UFO investigators, but I refused to confirm or deny their claims. A week ago I was telephoned from New York by a Mr Eric Mishara from Omnie Magazine. He asked me questions about an article in a British UFO Magazine. He claimed he was a serious UFO investigator and wanted to write an objective article about the incident. I told him that whoever wrote the article he described to me must have had a vivid imagination.

2. I have now managed to obtain a copy of the article and enclose a copy for your information. The magazine is called "The Unexplained" published weekly by:

ORBIS Publishing Ltd
 Orbis House
 20/22 Bedfordbury
 London WC2N 4BT

The article was in Volume 9 Issue No 106.

3. I now anticipate a flood of enquiries and would be grateful for some guidance on MOD Policy concerning UFO's.

D H MORELAND
 Sqn Ldr
 RAF Cdr

175

high-ranking US Air Force officers talk to the crew of a UFO that crashed in East Anglia? Or was the story a smokescreen for a potentially deadly military accident? JENNY RANGLES reports on the rumours and the evidence

THE STUDY OF ALLEGED CRASHES of alien craft does not enjoy a degree of respectability proportional to its importance. Many ufologists decry those who try to unravel the truth behind such mysteries, for there are major problems with all these stories. The crashes always seem to occur in remote desert regions. In nearly all of them many years elapse before they are investigated. And there are very few witnesses, all of whom demand strict confidentiality, 'for fear of reprisals'. They insist that the security lid on these events is so tight that if it were made public that they had spoken out they would live in fear of the consequences.

These criticisms are true even of the cases studied by Leonard Stringfield, the pioneer in this field. He has collected information on a whole series of American retrievals (as they are known in ufologists' jargon), and one, at least - the Kingman, Arizona, case of May 1953 - has an appreciable degree of support. His very important research was published in the United States and appeared in a three-part series in the respected British journal *Flying Saucer Review*. The Roswell case (see page 2034) is one of Stringfield's - and

The expanse of Rendlesham Forest, in Suffolk, set in flat, lonely countryside. Local people saw lights descending into the forest and Forestry Commission workers found scorched trees. The reports coincided with sensational stories emanating from a local air base, telling of a UFO landing

actually one of the most poorly supported. But where, we might wonder, are the recent crashes? Or the ones *not* in a desert area? Or the witnesses who *will* speak out? Well, some of these conditions may have been fulfilled by the remarkable incident at Rendlesham Forest, Suffolk, in East Anglia in December 1980.

Rendlesham Forest is a pretty woodland area about 12 miles (19 kilometres) east and north of Ipswich. It is surrounded by some of the most sparsely populated land in south-eastern England, farmland on which there are scattered farms. The only community of any real size is the village of Woodbridge to the west. North of the woods lie the US Air Force bases at Woodbridge and Bentwaters. These are important elements of the NATO defence system and would be of great strategic significance in the event of any future European war.

Between 27 and 30 December 1980 a number of reports of lights in the sky were made from this general area, especially around the coastal town of Leiston. A nuclear power station is nearby and some very interesting close encounters have been recorded in this vicinity. Brenda Butler and Dot Street, local investigators for the British UFO Research Association (BUFORA), followed up the sightings of the lights. They included one from a witness who said he observed a brilliant white light that hovered

Impact-and after

... a little enigmatic. It is the story that they usually jump at. Butler et suggest that there are indications lack of interest was due to influence places.

author Paul Begg heard one of the from an acquaintance in his local ar Rendlesham. This man said he as a radar operator in a civilian unit in the neighbouring county of . A friend had been on duty on 30 er and had tracked an unknown ading south (which was towards the ham Forest area). The radar return correspond to that of any known

ple of days later, there were surprise to the radar centre. US Air Force arrived and took away the tapes of the icking from the relevant night. They the civilian operators, in confidence, object they had tracked had landed on the Woodbridge airfield - and that id emerged. Personnel from the base roached in a jeep, the engine of which ad as it came close to the craft. The air rsonnel had then conversed with the

Begg reported the story to the and she asked Peter Warrington, a st investigator of radar cases, to up the case. He talked to the radar rs and got the same details from all of this occurred before any of the ants knew of the information that Butler and Dot Street possessed. editor of BUFORA's *Journal*, Norman also received an account of an in- the Woodbridge base. It essentially

... that something big had taken place there and, although lacking detail, was generally consistent with the information received by others. The story came from the United States, from a serviceman who had returned there after being stationed in England and therefore may have felt more free to talk.

Finally there was local gossip that 'something queer' had gone on at the air base. These stories involved an 'air crash' in the forest and did not seem to refer to a UFO. The belief that there had been a crash was strengthened by the report of a farmer who lived beside the wood and had seen a brightly lit object descend into the forest. He telephoned the base and suggested that one of their aircraft had come down. He was not

An A-10 ground attack aircraft of the US Air Force. According to an informant from the USAF base at Woodbridge, aircraft of this - type were sent over the area of the alleged UFO encounter the day after it happened, supposedly to monitor radioactivity. The aircraft is designed to fly safely at very low speeds and low altitudes, making it valuable for ground surveys

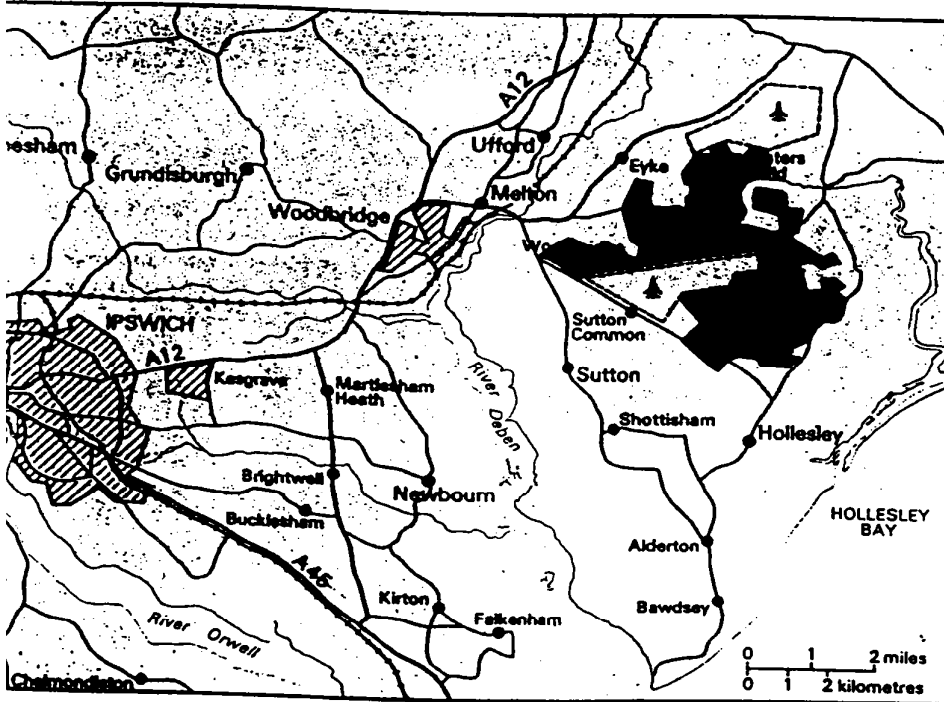
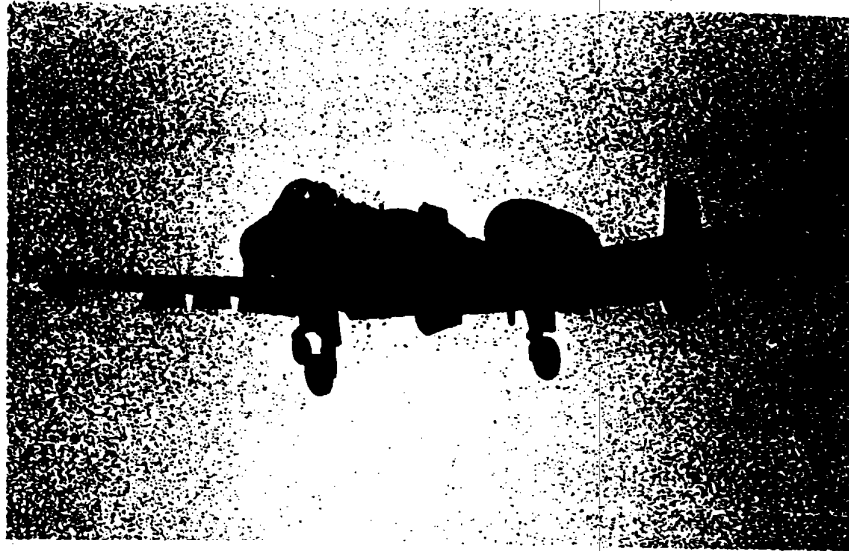

Left: the area of Suffolk that includes Rendlesham Forest and the nearest large town, Ipswich. The country around the forest is some of the loneliest in Britain. Two versions of the UFO encounter story are current: according to one, the object landed in the forest, roughly in the area marked by the red star; according to the other, it landed on the Woodbridge air base itself

177



above Rendlesham Forest for 20 minutes or more. Being used to the activity around the air bases he assumed he was seeing one of their aircraft, though he was puzzled as to why it remained over the woods for so long.

Early in January 1981 one of Brenda Butler's trusted contacts at the Woodbridge base passed an astonishing piece of information to her. He said that a UFO had come down in the forest, about 2 miles (3 kilometres) from the base. It seems that this was probably on 30 December. The contact, a high-ranking officer, visited the scene along with the base commander and security personnel. They carried no weapons - these were expressly forbidden. The commander talked for some time with small 'aliens', 3 feet (1 metre) tall and wearing silver suits, who were suspended in 'shafts of light' beside the landed craft.

Above: the ufologists who studied the wave of independent UFO reports centred on the Rendlesham Forest area: Dot Street (left) and Brenda Butler at the spot where they estimate that a brightly lit object, reported by a local farmer, must have descended. The Rendlesham case is more promising for research than the classic 'retrieval' cases compiled by the leading American ufologist Leonard Stringfield (above right), for the reports were nearly contemporary with the incidents described

had imparted about this incident.

Brenda Butler agreed to the officer's quest. She kept the story to herself throughout January, not even relating it to her colleague Dot Street. Even when she did her the story - about four weeks later, when rumours of the incident had begun to circulate from other sources - she continued to observe the officer's confidentiality. Consequently we are heavily reliant on her work. However, in discussions with the author she seemed both sincere and reliable.

A year later another investigator succeeded in confirming the existence of Brenda Butler's contact. Harry Harris, a lawyer and an investigator with the Manchester Research Association, spoke to the officer who confirmed the basic details as Brenda had reported them. However, he avoided subsequent attempts by Harris to communicate with him.

The rumour emerged during February 1981, through several channels. All independent of each other, of Brenda Butler and of the media. Indeed, considering the number of people in the area who seem to have heard about the events, this lack

Classified conversations

Brenda Butler's contact refused to tell her specific details of the shape of the object, which was apparently damaged and being repaired. He also refused to comment on the subject matter of the detailed conversations that took place. Eventually, he claimed, the UFO departed - unsteadily at first - and strict security was imposed on all personnel who knew of the affair. Photographs that had been taken by some officers, without permission, were immediately confiscated. The officer mentioned, provocatively, that this was not the first time that a UFO had landed near - or perhaps even on - the base.

This officer was willing to talk to Butler only because of their past dealings and on the strict understanding that his confidentiality should be preserved. She was also required, at first, not to make use of the information he

STATION RECORD FORM

470

SERIAL No. [] : RECEIVED VIA [] : SUB-DIV CODE 7334/30 :

INITIAL CODES [] : DATE 26.12.70 : TIME [] :

0010E1--0411-03- 32 - W2E-- BEYOND EAST GATE TO RAF WOODBRIDGE

SAG

ZCZC
 ROUTINE
 SEW SEW914 26120520
 26/12/80/0411

SER.NO- 10E1 REC-PHONE S/D-W CODE(1)-32 0 0 CODE(2)-32 0 0

MESSAGE- WE HAVE A SIGHTING OF SOME UNUSUAL LIGHTS IN THE SKY, HAVE SENT SOME UNARMED TROOPS TO INVESTIGATE, WE ARE TERMING IT AS A U.F.O. AT PRESENT

ATIC

LOCATION- BEYOND EAST GATE TO RAF WOODBRIDGE

JRM

INFORMER- A.I.C ARMOLD, LAW ENFORCEMENT DESK BENTWATERS

SECTOR- 03

ACTION(DIV)- W2E 0417 0439 0513 E0862

ACTION(FHQ)- E5P 0418 0436 0514 A0076

ION

RESULT- AIR TRAFFIC CONTROL WEST DRAYTON CHECKED, NO KNOWLEDGE OF AIRCRAFT, REPORTS RECEIVED OF AERIAL PHENOMENON SOUTHERN ENGLAND DURING THE NIGHT. ONLY LIGHTS VISIBLE THIS AREA WAS FROM ORFORD LIGHT HO USE. SEARCH MADE OF AREA- NEGATIVE. PCS 297 320

ARRESTS- 00

SUMMONS- 00

REPORTED BY- E5P

GRID REF- 0 0

RESULTED BY- 76

NNNN

(BLOCK CAPITALS PLEASE)

CONTROLLER'S INITIALS

s.F40

s.F40

s.F40

s.F40

CE
RK
EIV

26 12 80.

Law Enforcement Bentwaters report they
have found evidence of a raft landing
2 miles due East of the East Gate to
Woodbridge H. Post.

s.F40 Sgt. [redacted] to Cresswell attending.

s.F40 [redacted]

ZCZC
ROUTINE
SEW SEW917 26121158
26/12/80/1030

SER.NO- 31A4 REC-PHONE S/D-W CODE(1)-32 0 0 CODE(2)-32 0 0

MESSAGE- WE HAVE HAD A CALL FROM THE L.I.E. AT BENTWATERS IN
REFERENCE TO THE U.F.O. REPORTED LAST NIGHT. WE
HAVE FOUND A PLACE WHERE A CRAFT OF SOME SORT SEEM
S TO HAVE LANDED

LOCATION- APPROX. 2 MILES EAST OF THE EAST GATE AT BENTWATE
R5

s.F40 INFORMER- PC [redacted] WOOD S/DIV

SECTOR- 03

ACTION(DIV)- E0602

ACTION(FHQ)- A0604

W2R ATTENDING A0604

RESULT- THERE WERE THREE MARKS IN THE AREA WHICH DID NOT
FOLLOW A SET PATTERN. THE IMPRESSIONS MADE BY THE
SE MARKS WERE OF NO DEPTH AND COULD HAVE BEEN MADE
BY AN ANIMAL. PC CRESSWELL ATTENDED

ARRESTS- 00.

SUMMONS- 00

REPORTED BY-

GRID REF- 0 0

RESULTED BY- 604

LATE ENTRY 26/12/80

NNNN

SUFFOLK CONSTABULARY

Telephone No. 282178

FELIXSTOWE Police Station

32 High Road West
Felixstowe
Suffolk IP11 9JE

Our Ref: 18(2)F/88

27th October 1988

Dear Mr.  **s.F40**

I refer to your letter to Woodbridge Police Station dated 18th October 1988.

I can inform you that, at shortly after 4 a.m. on 26th December 1980, the police did receive a call reporting unusual lights being seen in the sky near R.A.F. Woodbridge. The police responded to this call, but there was no evidence to substantiate or indicate the presence of an unidentified flying object.

You may already be aware that three local residents also pursue your interest in U.F.O's and have written a book on this incident called 'Skycrash', namely, Brenda BUTLER, Dot STREET and Jenny RANGLES. Unfortunately, I do not know the name of the publishers, nor if it is still available for purchase.

I hope this helps you in your research.

Yours sincerely,

 **s.F40**

s.F40

Superintendent - Felixstowe Sub Division

s.F40

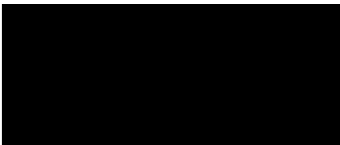



SUFFOLK CONSTABULARY

FORCE HEADQUARTERS, MARTLESHAM HEATH,
IPSWICH IP5 7QS Tel. Ipswich (0473) 624848 Telex: 98120

All official correspondence should be addressed to the Chief Constable

Your Ref.

Our Ref. 25(3)3/83 DJ/SRP

23 November 1983

Dear Sir

SIGHTING OF UNUSUAL LIGHTS IN THE SKY AT WOODBRIDGE ON 26 DECEMBER 80

With reference to your letter dated 3 November 83 which related to the above mentioned incident.

Police knowledge of this matter is limited to a telephone report of the alleged incident timed at 4.11 am on 26 December and received from a person at RAF Bentwaters together with the two subsequent visits to the location by police officers.

The first visit followed immediately the reported incident and the two officers who attended made a search of the area with a negative result. A note on the log indicates that Air Traffic Control at West Drayton were contacted and that there was no known knowledge of aircraft in that area to coincide with the time of the sighting. Mention is also made on the log of reports received of aerial phenomena over Southern England during that night. The only lights visible to the officers visiting the incident were those from Orford Light House.

A further report was received at 10.30 am on 26 December 80 from a staff member at RAF Bentwaters indicating that a place had been found where a craft of some sort could have landed. An officer attended and the area involved did bear three marks of an indeterminate pattern. The marks were apparently of no depth and the officer attending thought they could have been made by an animal.

It is considered little more would be gained by you making direct contact with the officers involved as the above information constitutes the sum of their knowledge in relation to this matter. It is hoped the information supplied will be of assistance to you in formulating your intended account of the circumstances.

Yours faithfully

Chief Constable

s.F40

000004

SUFFOLK CONSTABULARY



FACSIMILE TRANSMISSION

FORCE HEADQUARTERS
MARTLESHAM HEATH
IPSWICH IP5 3QS

s.F42

s.F42

s.F42

Tel: [REDACTED] Fax: [REDACTED] E-mail: [REDACTED]

DATE : 18 January 2001
 TO : Home Office Action Against Crime
 and Disorder Unit
 FAX NO. : s.F42 [REDACTED]
 FOR ATTENTION OF : s.F40 [REDACTED] Public Order Section
 ORIGINATOR : s.F40 [REDACTED] Executive Services Manager
 PAGES TO FOLLOW : 2

TEXT :

s.F40 [REDACTED]

s.F40

As discussed please find a copy of a letter sent to [REDACTED] in July 1999 which may be of use. As also discussed due to the period elapsed since the 'incident' it has not been possible to locate any files (due to them being stored in a different location). Furthermore the situation is exacerbated by the fact that most police officers serving at that time have since retired (including the author of the attached letter!).

I trust this will suffice.

s.F40 [REDACTED]
Executive Services Manager

000005

FORCE HEADQUARTERS, MARTLESHAM HEATH, IPSWICH IP5 7QS
Tel: Ipswich (01473) 613500 Telex: 98120 Fax: 474274
All official correspondence should be addressed to the Chief Constable

P J Scott-Lee Esq. QPM
Chief Constable

Your Ref:

Our Ref:

28 July 1999

s.F40

Dear [REDACTED]

INCIDENT IN RENDLESHAM FOREST - DECEMBER 1980

I refer to your letter of 22 July 1999 in relation to a series of unusual events which allegedly occurred outside the perimeter of RAF Woodbridge, Suffolk, during the last week of December 1980.

A great deal of interest has understandably been generated in respect of this story, not least because of the apparent number and standing of witnesses. However, over the intervening years, various reports of the incident(s) seem to have taken on a life of their own to the extent that the 'sighting' details and corroborative evidence have been substantially embellished. This contrasts sharply with the views of the local police who attended at the time and did not perceive this occurrence as being anything unusual considering the festive significance of the date and expected high spirits.

Such a perception lends support to the lack of police documentary evidence and one needs to understand the minimalistic nature of rural policing in order to appreciate the answers which I will attempt to give to your questions. s.F40 s.F40

(1) Both Pc [REDACTED] and Pc [REDACTED] have retired from the force but, being a long standing friend of the former, I have spoken to him recently and at great length in response to other similar journalistic enquiries. He does not recall making any official report and there is no evidence that one was made.

s.F40

s.F40

(2) [REDACTED] has confirmed that he and Pc [REDACTED] were in the Law Enforcement Office at RAF Bentwaters when they were diverted to a 'higher priority' task at Otley post office. As rural night-duty officers they would have sole responsibility for policing a huge territorial area (approx 400 square miles) and would certainly have treated a post office burglary as more important than a recurrence of an earlier incident which was seen as somewhat frivolous.

(3) Pc Brian Cresswell's (also now retired) visit to the alleged landing site would not have generated more than a standard incident log unless he was convinced that something worth reporting had occurred.

s.F40

Pc [REDACTED] had discussed the matter with him and it appeared that all three officers were equally unimpressed with the nights events.

(4) Civilian police officers were not employed in guarding the area surrounding the alleged landing site(s) or to deter access as there was no evidence to indicate that anything of immediate concern to the police had occurred.

s.F40

continued

000006

(5) There is no documentary evidence that police officers were involved in similar incidents on 27-31 December that year and Pc [REDACTED] cannot recall any further requests for police attendance.
s.F40

(6) Special Branch officers should have been aware of the incident(s) through having sight of the Incident Log(s) but would not have shown an interest unless there was evidence of a potential threat to national security. No such threat was evident.

I have tried to be as objective as possible with the answers provided and, like yourself, would undoubtedly be pleased to see a local incident such as this substantiated as an authentic 'UFO' experience. Pc [REDACTED] holds similar views to myself and returned to the forest site in daylight in case he had missed some evidence in the darkness. There was nothing to be seen and he remains unconvinced that the occurrence was genuine. The immediate area was swept by powerful light beams from a landing beacon at RAF Bentwaters and the Orfordness lighthouse. I know from personal experience that at night, in certain weather and cloud conditions, these beams were very pronounced and certainly caused strange visual effects.

If you have any other query in respect of this subject I will be pleased to discuss the issues further. My direct dial telephone number is [REDACTED] s.F42

Yours sincerely,



[REDACTED] s.F40

Inspector - Operations (Planning)